

MATRICE 300 RTK

User Manual

v1.6 2020.11

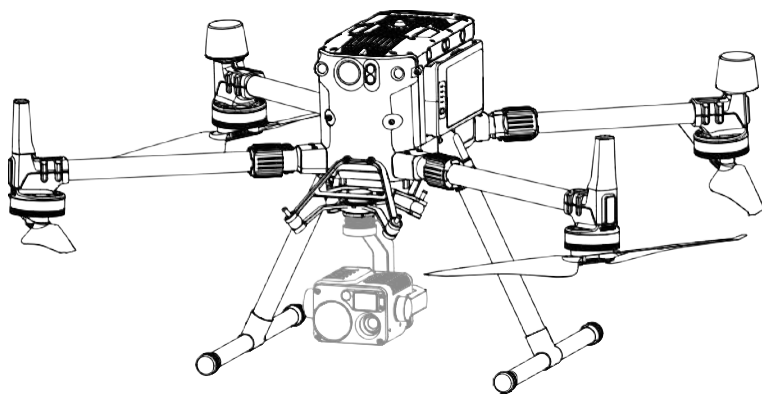

Searching for Keywords

Search for keywords such as “battery” and “install” to find a topic. If you are using Adobe Acrobat Reader to read this document, press Ctrl+F on Windows or Command+F on Mac to begin a search.

Navigating to a Topic

View a complete list of topics in the table of contents. Click on a topic to navigate to that section.

Printing this Document

This document supports high resolution printing.

Using This Manual

Legends

 Warning

 Important

 Hints and Tips

 Reference

Before Flight

The following materials have been produced to help users make full use of the M300 RTK.

1. In the Box
2. Disclaimer and Safety Guidelines
3. Quick Start Guide
4. Intelligent Flight Battery Safety Guidelines
5. User Manual

Watching all the tutorial videos and reading the Disclaimer and Safety Guidelines before flight is recommended. Afterwards, prepare for your first flight by using the Quick Start Guide. Refer to this manual for more comprehensive information.

Download the DJI Pilot app

The DJI Pilot app is required if using a mobile device connected to the remote controller. Search for Scan the QR code or visit https://m.dji.net/djipilot_enterprise to download the app. DJI Pilot supports Android 5.0 or later.



* For increased safety, the flight is restricted to a height of 30 m and distance of 50 m when not connected or logged into the app during flight, including DJI Pilot and all apps compatible with DJI aircraft.

Download the DJI Assistant 2 for Matrice

Download and install the ASSISTANT™ 2 for Matrice before use.
<https://www.dji.com/matrice-300/downloads>



The operating temperature of this product is -20° to 50° C. It does not meet the standard operating temperature for military grade application (-55° to 125° C), which is required to endure greater environmental variability. Operate the product appropriately and only for applications that it meets the operating temperature range requirements of that grade.

Contents

| | |
|---|----|
| Using This Manual | 2 |
| Legends | 2 |
| Before Flight | 2 |
| Download the DJI Pilot app | 2 |
| Download the DJI Assistant 2 for Matrice | 2 |
| Product Profile | 6 |
| Introduction | 6 |
| Feature Highlights | 6 |
| Preparing the Aircraft | 8 |
| Aircraft Diagram | 10 |
| Remote Controller Diagram | 11 |
| Aircraft | 14 |
| Profile | 14 |
| Flight Mode | 14 |
| Flight Status Indicator | 15 |
| Aircraft Beacons | 16 |
| Aircraft Auxiliary Lights | 16 |
| Vision System and Infrared Sensing System | 17 |
| Return-to-Home (RTH) | 22 |
| Center of Gravity Calibration | 26 |
| Flight Recorder | 26 |
| Propellers | 26 |
| Intelligent Battery Station | 27 |
| Intelligent Flight Battery | 33 |
| DJI Intelligent Flight Battery Functions | 33 |
| D-RTK | 36 |
| DJI AirSense | 37 |
| Expansion Ports | 38 |
| IP45 Protection Rating | 38 |
| Remote Controller | 40 |
| Profile | 40 |
| Preparing the Remote Controller | 40 |
| Remote Controller Operations | 44 |

| | |
|--|-----------|
| Advanced Dual Operator Mode | 50 |
| Video Transmission Descriptions | 51 |
| Display Interface | 52 |
| Gimbal and Camera | 60 |
| DJI Pilot App | 62 |
| Manual Flight | 62 |
| Mission Flight | 75 |
| Album | 80 |
| DJI FlightHub | 80 |
| Menu | 80 |
| Flight | 82 |
| Flight Environment Requirements | 82 |
| GEO (Geospatial Environment Online) System | 82 |
| Flight Restrictions | 83 |
| GEO Unlocking | 86 |
| Preflight Checklist | 86 |
| Calibrating the Compass | 86 |
| Flight Test | 88 |
| Starting/Stopping the Motors | 88 |
| Three-propeller Emergency Landing | 89 |
| Appendix | 91 |
| Specifications | 91 |
| Firmware Update | 93 |
| Using the Upward Gimbal Connector | 95 |
| Using the Dual Gimbal Connector | 95 |
| Using the CSM Radar | 97 |
| Carrying Case Description | 99 |
| Using the Aircraft Cradle | 100 |
| Extended Screw Holes Description | 100 |

Product Profile

This chapter describes the features of the Matrice 300 RTK, shows how to assemble the aircraft, and contains diagrams of the aircraft and remote controller with component explanations.

Product Profile

Introduction

The MATRICE™ 300 RTK (M300 RTK) is a powerful industrial drone platform with an advanced flight controller system, 6 Directional Sensing and Positioning system and FPV camera. To enhance reliability and safety, it also supports CSM Radar - an additional obstacle detection component that can be mounted on top of the drone. It features several advanced flight functions including 6 directional sensing and positioning*, AI spot-check*, Smart Track*, PinPoint*, Location Sharing, Primary Flight Display and more. The built-in AirSense provides awareness of nearby aircraft within the surrounding airspace to ensure safety.

Its airframe design gives it an IP45 Ingress Protection, in accordance with the global IEC 60529 standard. The mechanical design, along with quick-release landing gears and mounted folding arms, makes it easy to transport, store, and prepare for flight. The safety beacons on both the top and the bottom of the aircraft allow the aircraft to be identified at night or in low light conditions. The auxiliary lights help the vision positioning system achieve better performance at night or in low light conditions, improving aircraft takeoff, landing and flight safety.

M300 RTK is compatible with many of DJI's DGC2.0 connector gimbals, supporting multi-gimbal system, which can support up to three independent gimbals to meet the needs of different scenarios.**

The Matrice 300 RTK is equipped with several expansion ports for broader applications. It has a built-in RTK module, which provides more accurate heading data for positioning.** An advanced power management system along with dual batteries ensures power supply and enhances flight safety. Without a payload, the M300 RTK has a flight time of up to 55 minutes.***

* Must be used with the H20 series gimbal and camera.

** The Vision and Infrared Sensing Systems are affected by surrounding conditions. Read the Disclaimer and Safety Guidelines to learn more. Gimbals can be purchased separately from the official DJI website. Please refer to the user manual for more details about expansion ports, upward gimbals, and downward gimbals.

*** Please note that maximum flight time is measured in ideal flight conditions. Actual flight time may vary depending on your environment.

Feature Highlights

The flight controller provides a safe and reliable flight experience. A flight recorder stores critical data from each flight. Dual IMUs and barometers design provide additional redundancy. The aircraft can hover and fly in extremely low altitude and indoor environments, and provides 6 directional obstacle sensing and vision positioning functions.

The built-in AirSense system alerts you of nearby aircraft in the surrounding airspace to ensure safety. The safety beacons on both the top and the bottom of the aircraft allow the aircraft to be identified at night or in low light conditions. The auxiliary lights help the vision positioning system achieve better performance at night or in low light conditions, improving aircraft takeoff, landing and flight safety. The airframe design gives the aircraft an IP45 Ingress Protection, in accordance with the global IEC 60529 standard.

Powered by a new design of software and hardware platform, M300 RTK boasts multiple intelligent features. With the H20 series, M300 RTK supports AI Spot-check to take photos during flight for Demo Flight, save as Flight Mission, and the aircraft can automatically take photo at the same position when each Flight Mission is performed. PinPoint enables users to mark fixed subjects and share location in real-time. Smart Track is used to autonomously identify subjects and keep track of mobile ones. The

subject is centered and in the right size, and shares its location in real-time thanks to auto zoom. A new Primary Flight Display presents the necessary flight status clearly and visually in the FPV view, aiming to ensure the user's flight safety and efficiency.

The DJI Smart Controller Enterprise (hereinafter referred to as "Smart Controller") features OCUSYNC™ Enterprise technology, capable of controlling aircraft that supports this technology, and providing a live HD view from the aircraft's camera. It can transmit image data at distances of up to 9.32 mi (15 km) and comes with a number of aircraft and gimbal controls as well as some customizable buttons. The built-in 5.5-inch high brightness 1000 cd/m² screen has a resolution of 1920×1080 pixels, featuring an Android system with multiple functions such as Bluetooth and GNSS. In addition to supporting Wi-Fi connectivity, it is also compatible with other mobile devices for more flexible usage. An HDMI port is available for HD images and video output. The transmission system supports 2.4 GHz and 5.8 GHz to ensure a more reliable connection in environments prone to signal interference. The AES-256 encryption keeps your data transmission secure so you can be sure that your critical information remains safe.*

The TimeSync system continuously aligns the flight controller, camera, GNSS module, as well as onboard accessories via the Payload SDK or Onboard SDK at the microsecond level. It meets SDK developers' requirements on time precision.

An advanced power management system along with dual batteries ensures power supply and enhances flight safety. Without a payload, the aircraft has a flight time of up to 55 minutes. The batteries can be replaced when without powering off the aircraft, enabling non-stop, continuous operations.

The camera unit is independent from image processor so that you have the flexibility to choose the perfect gimbal and camera system (including ZENMUSE™ XT2 / XT S** / Z30 / H20, and H20T) for each of your application. This means that regardless of which camera you choose, you have the same powerful processing backing it. The M300 RTK allows for multiple payload configurations. It supports an upward gimbal, a single downward gimbal, dual downward gimbals, or an upward gimbal + a downward gimbal. It is equipped with many expansion ports for broader applications.

The aircraft has a built-in RTK module, which provides more accurate heading data for positioning. More accurate positioning data can be achieved when using with a DJI D-RTK 2 High Precision GNSS Mobile Station.

* The Smart Controller can reach its maximum transmission distance (FCC) in an unobstructed area with no electromagnetic interference at an altitude of about 400 feet (120 meters). The actual maximum transmission distance may be less than the distance mentioned above due to interference in the operating environment, and the actual value will fluctuate according to the strength of interference. To comply with local regulations, the 5.8 GHz frequency is not available in some countries and regions.

** The Zenmuse XT S is only available in select countries and regions.

Preparing the Aircraft

Installing the Landing Gears

Install the landing gears, slide the gear lock to the end of the landing gear, then rotate it about 90° until the dot is in sync with the alignment mark.

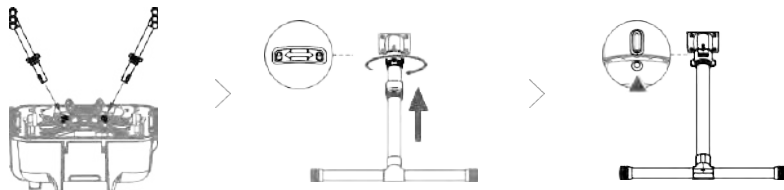

Unfolding the Aircraft

Remove the two propeller holders.

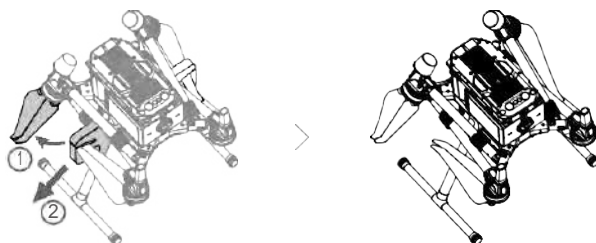

Unfold the frame arms on both sides in the same way.

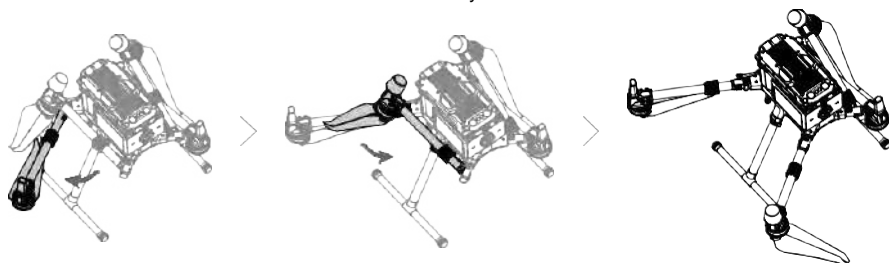

Lock the frame arms and unfold the propellers.

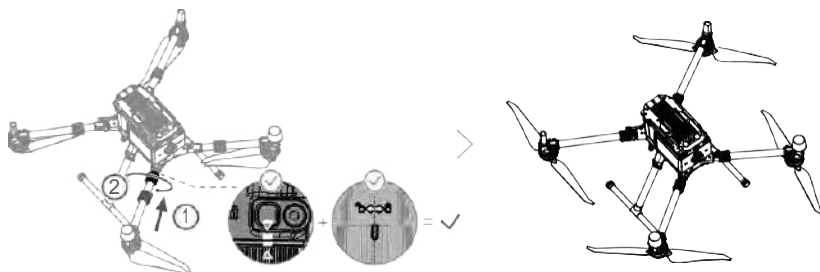

Mounting the Gimbal and Camera



Press the Gimbal Detachment button to remove the cover.



Align the white and red dots and insert the gimbal.



Rotate the gimbal lock to the locked position.

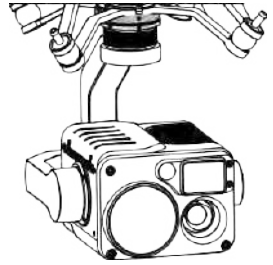

- After installation, make sure that the gimbal lock is locked in place.

Mounting the Intelligent Flight Batteries / Checking the Battery Level

Insert a pair of batteries.

Press the battery level button once to check the battery level.

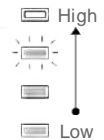
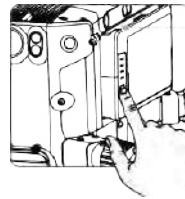
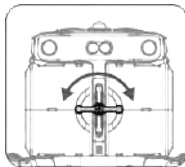
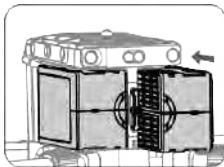

Turn on / off: Press the power button on the aircraft, within 3 seconds press again and hold to turn on / off the aircraft, with the power indicator solid on.

Link: Press and hold the aircraft's power button at least five seconds to link the aircraft and Smart Controller. The power indicator will blink during linking.

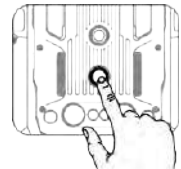

- If for any unforeseeable circumstances, that only one battery is available during flight, land the aircraft immediately and replace the batteries as soon as possible.
- The PSDK and OSDK ports have built-in temperature sensors. If the device temperature is too high due to too large payload power, the aircraft will automatically power off the payload for protection.
- Make sure to use the included batteries. DO NOT use any other type of batteries.

Aircraft Diagram

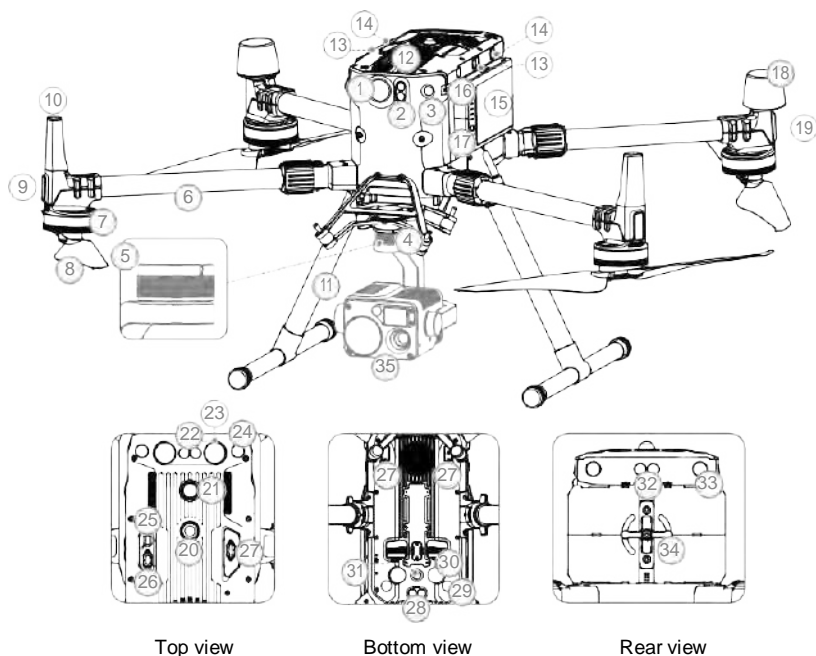

- | | |
|--|--------------------------------------|
| 1. FPV Camera | 19. Aircraft Status Indicators |
| 2. Forward Infrared Sensing System | 20. Upward Beacon |
| 3. Forward Vision System | 21. Power Button / Indicator |
| 4. DJI Gimbal Connector v2.0 (DGC2.0) | 22. Upward Infrared Sensing System |
| 5. Gimbal Detachment Button | 23. Top Auxiliary Light |
| 6. Frame Arms | 24. Upward Vision System |
| 7. Motors | 25. Assistant Port |
| 8. Propellers | 26. OSDK Port |
| 9. ESC LEDs | 27. PSDK Port* |
| 10. Transmission Antennas | 28. Downward Infrared Sensing System |
| 11. Landing Gears | 29. Downward Vision System |
| 12. Air Filter | 30. Bottom Auxiliary Light |
| 13. Left and Right Infrared Sensing System | 31. Downward Beacon |
| 14. Left and Right Vision System | 32. Backward Infrared Sensing System |
| 15. Intelligent Flight Batteries | 33. Backward Vision System |
| 16. Battery Level Indicators | 34. Battery Locker |
| 17. Battery Level Button | 35. Gimbal and Camera |
| 18. D-RTK Antennas | |

* The two PSDK ports on the bottom of the aircraft also serve as 1st gimbal port and 2nd gimbal port. Please note that the single downward gimbal must be connected to 1st gimbal port.

Remote Controller Diagram

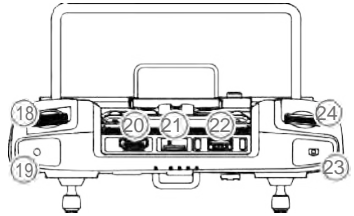
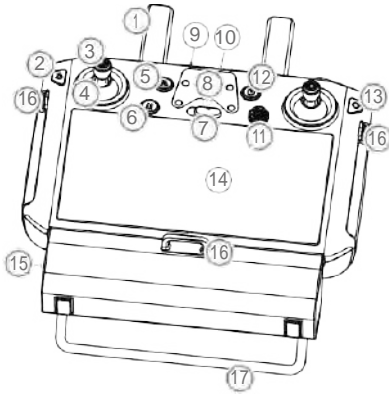

1. Antennas
2. Back Button / Function Button
Press once to return to the previous page and press twice to go back to the homepage. Hold to view a guide to using button combinations. Refer to the Button Combinations section for more information.
3. Control Sticks
4. Stick Covers
5. RTH Button
6. Flight Pause Button
7. Flight Mode Switch
8. Position for Mounting Bracket (with built-in GPS module under it)
9. Status LED
10. Battery Level LEDs
11. 5D Button
The default configuration is listed below. The functions can be set in DJI Pilot.
Up: Camera zoom in
Down: Camera zoom out

Left: Decrease EV value
Right: Increase EV value
Go to Settings > Control Stick Navigation to enable this function.

12. Power Button
13. Confirm Button
14. Touch Screen
15. Charging Port (USB-C)
16. Lanyard Hooks
17. Handle
18. Gimbal Pitch Control Dial
19. Record Button
20. HDMI Port
21. microSD Card Slot
22. USB-A Port
Use to connect external devices, or connect to your PC for firmware update.
23. Focus / Shutter Button
Half press to focus, and then press to take a photo.

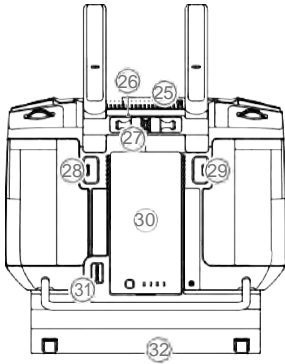

- 24. Gimbal Pan Control Dial
- 25. Air Vent
- 26. Sticks Storage Slot
- 27. Spare Sticks
- 28. Customizable Button C2
- 29. Customizable Button C1
- 30. WB37 Intelligent Battery
- 31. Battery Release Button
- 32. Dongle Compartment Cover

Aircraft

This section describes the features of the Flight Controller, Vision System, and the Intelligent Flight Battery.

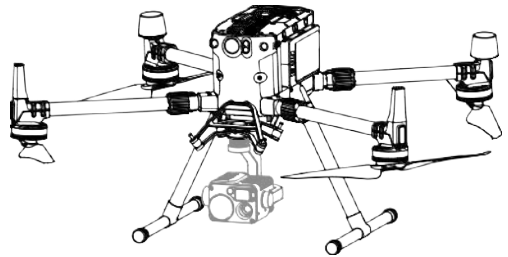

Aircraft

Profile

The M300 RTK aircraft includes a flight controller, a communication system, vision systems, a propulsion system and an Intelligent Flight Battery. This section describes the functions of these components.

Flight Mode

The following flight modes are available for the aircraft:

P-mode (Positioning) :

P-mode works best when the GNSS signal is strong. The aircraft utilizes the GNSS module and Vision Systems to locate itself, automatically stabilize, and navigate between obstacles. When the obstacle sensing is enabled and lighting conditions are sufficient, the maximum flight attitude angle is 25°. When the GNSS signal is weak and lighting conditions are too dark for the Vision Systems, the aircraft will only use its barometer for positioning to control altitude.

S-mode (Sport):

The aircraft uses GNSS for positioning. Aircraft responses are optimized for agility and speed making it more responsive to stick movements. As obstacle avoidance functions are disabled, the aircraft will not be able to sense and avoid obstacles when in Sport Mode. Only the vision positioning functions are available.

T-mode (Tripod):

T-mode is based on P-mode and the flight speed is limited, which makes the aircraft more stable during shooting.



- The obstacle avoidance function is disabled in S-mode (Sport), which means the aircraft will not be able to automatically avoid obstacles in its flight path. Be vigilant and stay clear of nearby obstacles.
- The aircraft's maximum speed and braking distance are significantly increased in S-mode (Sport). A minimum braking distance of 164 feet (50 meters) is required in windless conditions. The aircraft's responsiveness is significantly increased in S-mode (Sport), which means a small stick movement on the remote controller will translate into a large travel distance of the aircraft. Be vigilant and maintain adequate maneuvering space during flight.



Use the Flight Mode switch on the remote controller to select aircraft flight modes.

Attitude Mode Warning

DO NOT switch from P-mode to either S-mode or T-mode unless you are sufficiently familiar with the aircraft's behavior under each flight mode. You must turn on the "Multiple Flight Modes" setting in the app before you can switch from P-mode to other modes.

The aircraft will automatically enter Attitude mode when both of the following conditions are met: (1) the vision system is unavailable and (2) either there is weak GNSS signal or the compass experiences interference.

Users can also manually switch to the attitude mode, and the T/P/S mode can be set to A/P/S mode in the app.

In Attitude mode, the Vision System and some advanced features are disabled. Therefore, the aircraft cannot position or auto-brake in this mode and is easily affected by its surroundings, which

may result in horizontal shifting. Use the remote controller to position the aircraft.

Maneuvering the aircraft in Attitude mode can be difficult. DO NOT fly the aircraft too far away as you might lose control and cause a potential hazard. Avoid flying in areas where GNSS signal is weak, or in narrow and confined spaces. The aircraft will otherwise be forced to enter Attitude mode, leading to potential flight hazards, please land it in a safe place as soon as possible.

Flight Status Indicator



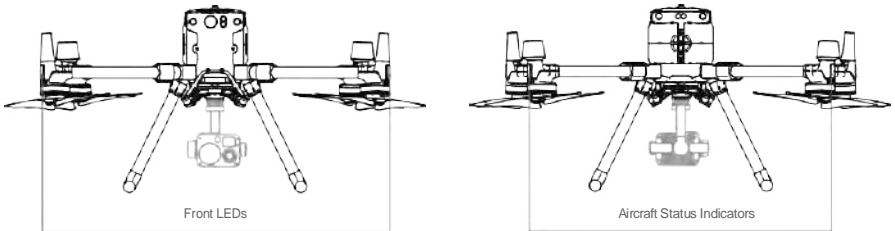



The aircraft features Front LEDs, and Aircraft Status Indicators. The positions of these LEDs are shown in the figure below:









1. The Front LEDs show the orientation of the aircraft.
2. The Aircraft Status Indicators communicate the system status of the flight controller. Refer to the table below for more information about the Aircraft Status Indicators.

 The Front LEDs, and Aircraft Status Indicators can be turned off in the DJI Pilot app for unobtrusive drone operations.

Aircraft Status Indicator Description

| Normal | | |
|--|-------------------------------------|---|
|  | Red, green, and yellow flashes | Turning On and Self Diagnostic Testing |
|  | Slow green flashing | P-mode with GNSS positioning* |
|  | Two green flashes | P-mode with Vision Systems* |
|  | Alternating green and blue flashing | The RTK function is enabled and RTK data is used. |
|  | Slow yellow flashing | A-mode (no GPS and vision positioning) |
|  | Fast green flashing | Braking automatically after obstacle detected |

| Warning | | |
|--|----------------------|-------------------------------|
|  | Fast yellow flashing | Remote Controller Signal Lost |
|  | Slow red flashing | Low Battery Warning |
|  | Fast red flashing | Critical Low Battery Warning |

| | | |
|--|--|--|
|  | Red flashing for 5 seconds (when performing CSC) | IMU Error |
|  | Solid Red | Critical Error |
|  | Fast alternating red and yellow flashing | Compass Calibration Required |
|  | Alternating red and green flashing | The RTK function is enabled but RTK data is unavailable. |

* Slow green flashes indicate P-mode, and fast green flashes indicate S-mode.

Aircraft Beacons

Enables aircraft identification during flight at night or in low light areas.

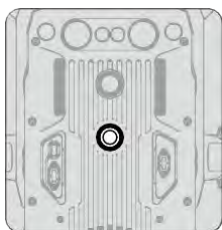

Top view

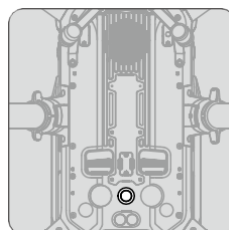

Bottom view

 DO NOT look directly at the beacons when they are in use to avoid damage to your eyes.

Aircraft Auxiliary Lights

The Auxiliary Lights located at the top and bottom of the aircraft improve visibility for the Vision System in poor light conditions.

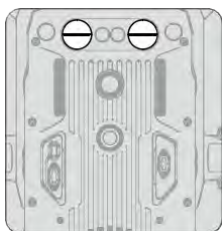

Top view

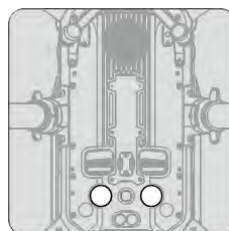

Bottom view

 The Auxiliary Light is automatically enabled when the environment light is too weak and the flight altitude is lower than 5 m. Please note that the Vision System's camera performance may be affected when the auxiliary bottom light is enabled. Fly with caution if the GNSS signal is weak.

Vision System and Infrared Sensing System

Introduction

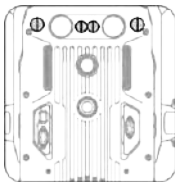
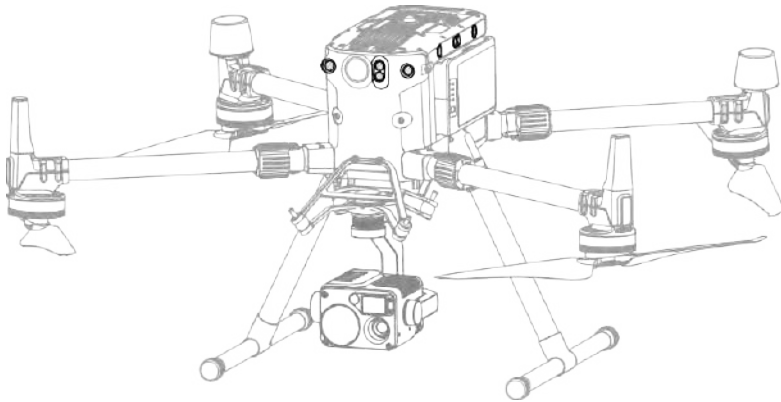

Top view

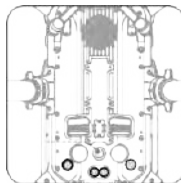

Bottom view

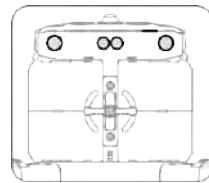

Rear view

The main components of the Vision System are located on the front, rear, left, right, top and bottom of the aircraft, including stereo vision sensors. The Infrared Sensing System consists of two infrared sensors on the front, rear, left, right, top and bottom of the aircraft.

The Vision System uses image data to help the aircraft constantly scan for obstacles and obtain the aircraft position information, and the Infrared Sensing System uses the infrared modules to detect obstacles to judge the aircraft height, allowing the aircraft to maintain its current position, enabling precision hovering indoors or other environments.



To ensure steady flight and general flight safety, DO NOT block the visual and infrared sensors.

Detection Range of the Vision System

The detection range of the Vision System is depicted below. Note that the aircraft cannot sense and avoid obstacles that are not within the detection range.

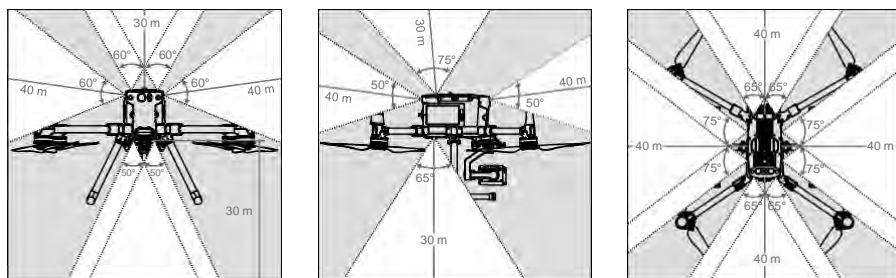

Detection Range of the Infrared Sensing System

The detection range of the infrared sensors is 8 m. Note that the aircraft cannot sense and avoid obstacles that are not within the detection range.

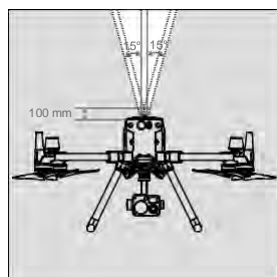

Not Obstruct Zone Note

A note on the Vision System and the ultrasonic sensor detection range is illustrated below.

There may be a $\pm 2^\circ$ error in the angle of the Vision System due to errors in the assembly process. To prevent accidents, please **DO NOT** attach any payload that might be in the sensors' Do Not Obstruct Zone. If the payload comes into the Do Not Obstruct Zone, it is recommended to turn off the vision system in the Pilot app and fly with caution.

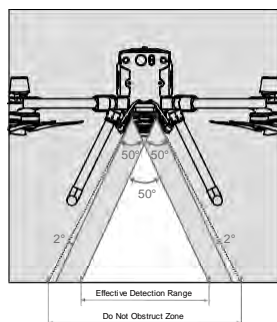

Calibration

The Vision System cameras installed on the aircraft are factory calibrated. If the aircraft experiences a collision or the working temperature has changed significantly, it may require calibration via DJI Assistant 2 for Matrice. Connect the aircraft to a computer and calibrate the Vision System cameras when prompted in DJI Pilot.

1. Power on the aircraft.
2. Connect the aircraft and the PC with a USB-C cable.
3. Launch DJI Assistant 2 for Matrice and log in with a DJI account.
4. Click M300 RTK and the calibration button.
5. Place the side of visual calibration plate with the dots facing the Vision System, and follow the instructions in the DJI Assistant 2 to complete calibration.

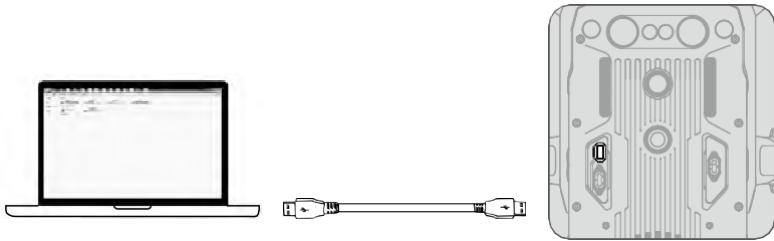

 DO NOT power off or unplug the USB-C cable after calibration. Wait for data calculation.

Using the Vision System

The Vision System enables precision hovering indoors or in environments where GNSS signal isn't available.

When the GNSS signal is available, the Vision System provides auxiliary information for improving aircraft positioning accuracy. The Vision System can work well when within 30 m from the ground and horizontal of 20 m of a wall or other objects to its side, requiring surfaces of clear patterns and adequate lighting.

When the Vision System and Infrared Sensing System are disabled, the flight mode will switch to Attitude Mode.

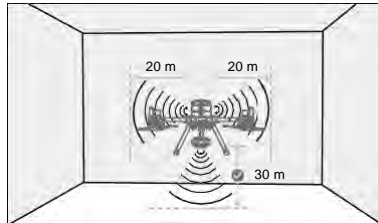

Follow the steps below to use the Vision System:

1. Ensure the aircraft is in P-mode and place the aircraft on a flat surface.
2. Turn on the aircraft. The aircraft will hover in place after takeoff. The aircraft status indicators will flash green twice, which indicates the Vision System is working.



⚠ If the Vision System shuts down or is blocked by other objects, the aircraft will not be able to hover at a low altitude indoors and the Landing Protection Function that controls the landing speed will be disabled. Note: the aircraft may be damaged by landing too fast.

Powered by the Vision System, the aircraft is able to actively brake when obstacles are detected in front. Obstacle Sensing works best when lighting is adequate and the obstacle is clearly textured. The aircraft must fly at no more than 38 mph (62 kph) with a maximum pitch angle of 25° to allow for sufficient braking distance.

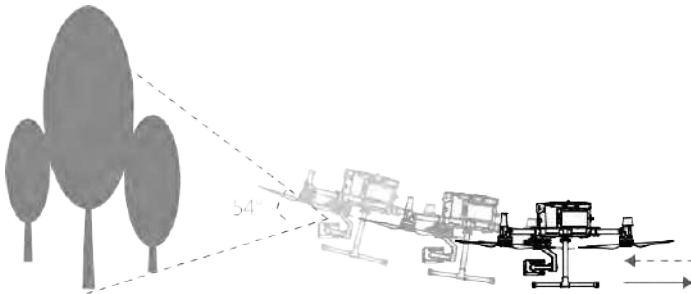

Using Infrared Sensing System

The Infrared Sensing System can only be used to avoid large, diffuse, and reflective obstacles (reflectivity >10%). Please be mindful of blind spots (Grey) of the Infrared Sensing System. The downward Infrared Sensing System is used for positioning and assisting height setting during takeoff and landing, while the Infrared Sensing System on the other five sides are for obstacle sensing.

Vision System and Infrared Sensing System Warning

The measurement accuracy of the Vision System is easily affected by the light intensity and the surface texture of the object. The Infrared Sensing System can only be used to avoid large, diffuse, and reflective obstacles (reflectivity >10%).

The Vision System may NOT function properly when in any of the following situations:

- a. Flying over monochrome surfaces (e.g., pure black, pure white, pure red, pure green) or without clear texture.
- b. Flying over highly reflective surfaces.
- c. Flying over water or transparent surfaces.

- d. Flying over moving surfaces or objects (e.g. above moving people, waving reeds, shrubs and grass).
- e. Flying in an area where the lighting changes frequently or drastically, or in an area where there is excessive exposure to direct, strong lighting.
- f. Flying over extremely dark (< 15 lux) or bright (> 10,000 lux) surfaces.
- g. Flying at high speeds (over 14 m/s at 2 meters or over 5 m/s at 1 meter).
- h. Tiny obstacles.
- i. The lens is dirty (e.g., due to raindrops, fingerprints, etc.).
- j. Scenes with low visibility (e.g., heavy fog).

The Infrared Sensing System may NOT provide an accurate distance when in any of the following situations:



- a. Flying over surfaces that can absorb sound waves (e.g., pure black matt objects).
- b. There is a large area of strong reflectors beyond 15 m (for example, multiple traffic signs are placed side by side).
- c. Tiny obstacles.
- d. Mirror or transparent objects (such as mirrors, water, and glass).



- Keep sensors clean at all times. Dirt or other debris may adversely affect their effectiveness.
 - The Vision System may not function properly when the aircraft is flying over water.
 - The Vision System may not be able to recognize pattern on the ground in low light conditions (less than 100 lux).
-

Return-to-Home (RTH)

The Return-to-Home (RTH) function brings the aircraft back to the last recorded Home Point when there is a strong GNSS signal. There are three types of RTH: Smart RTH, Low Battery RTH, and Failsafe RTH. This section describes these three RTH types in detail.

| ☐ | GNSS | Description |
|------------|---|---|
| Home Point |  | If a strong GNSS signal was acquired before takeoff, the Home Point is the location from which the aircraft launched. The GNSS signal strength is indicated by the GNSS icon  . Less than 4 bars is considered a weak GNSS signal. The aircraft status indicator will blink green rapidly when the home point is recorded. |

 The aircraft can sense and avoid obstacles when the Forward Vision System is enabled and lighting conditions are sufficient. To ensure the aircraft returns home while facing forward, it cannot rotate or fly left and right during RTH.

Smart RTH

Low Battery RTH

The low battery level failsafe is triggered when the DJI Intelligent Flight Battery is depleted to a point that may affect the safe return of the aircraft. Users are advised to return home or land the aircraft immediately when prompted. The DJI Pilot app will display a notice when a low battery warning is triggered. The aircraft will automatically return to the Home Point if no action is taken after a ten-second countdown. The user can cancel the RTH procedure by pressing the RTH button on the remote controller. The thresholds for these warnings are automatically determined based on the aircraft's current altitude and distance from the Home Point. If the RTH procedure is cancelled following a low battery level warning, the Intelligent Flight Battery may not have enough charge for the aircraft to land safely, which may lead to the aircraft crashing or being lost. Low Battery RTH can be turned off in DJI Pilot app.

The aircraft will land automatically if the current battery level can only support the aircraft long enough to descend from its current altitude. The user cannot cancel the auto landing but can use the remote controller to alter the aircraft's orientation during the landing process.

The Battery Level Indicator is displayed in the DJI Pilot app, and is described below:

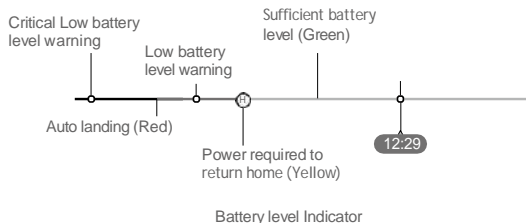

| Battery Level Warning | Remark | Aircraft Status Indicator | DJI Pilot App | Flight Instructions |
|------------------------------------|---|---|--|--|
| Low battery level warning | Battery power is low. Land the aircraft. | Aircraft status indicator blinks RED slowly. | Tap “Go-home” to have the aircraft return to the Home Point and land automatically, or “Cancel” to resume normal flight. If no action is taken, the aircraft will automatically go home after 10 seconds. Remote controller will sound an alarm. | If RTH is selected, the aircraft will fly back to the Home Point automatically and Landing Protection* will be triggered. Users can regain control during RTH. NOTE: The low battery level warning will not appear again after users regain control. |
| Critical Low battery level warning | The aircraft must land immediately. | Aircraft status indicator blinks RED quickly. | The DJI Pilot app display will flash red and the aircraft will start to descend. The remote controller will sound an alarm. | Allow the aircraft to descend automatically and trigger Landing Protection*. |
| Estimated remaining flight time | Estimated remaining time is based on current battery level. | N/A | N/A | N/A |



- When the Critical Low battery level warning is triggered and the aircraft begins to land automatically, push the left stick upward to make the aircraft hover at its current altitude, giving you an opportunity to navigate to a more appropriate landing location.
- The colored zones and markers on the battery level indicator bar reflect the estimated remaining flight time. They are automatically adjusted according to the aircraft’s current location and status.

Failsafe RTH

Failsafe RTH (enabled in the app) is automatically activated if the remote controller and the aircraft are disconnected. Failsafe RTH includes two stages of return to home: historical flight path and Smart RTH. When Failsafe RTH is enabled, the aircraft will return to home based on its historical flight path. Within a maximum distance of 50 meters, the aircraft will try to reconnect to the remote controller. If the aircraft cannot reconnect to the remote controller within 50 meters or the aircraft detects obstacles in front of it (enroute to its return to home flight path), the aircraft will exit the stage of return to home (based on its historical path), and enter the Smart RTH stage. When the remote controller is connected to the aircraft during return to home, users can use the remote controller to control the aircraft’s flight speed and altitude, and cancel Return to Home by pressing the RTH button on the remote controller.

RTH Procedure

1. Home Point is recorded automatically.
2. RTH procedure is triggered, i.e., Smart RTH, Low-Battery RTH, and Failsafe RTH.
3. Home Point is confirmed and the aircraft adjusts its orientation.
4. a. The aircraft will ascend to the pre-set RTH altitude and then fly to the Home Point when the aircraft's ground distance is further than 20 m from the Home Point or the flight height is larger than 30 m. Check and make sure RTH Obstacle Detection is enabled on DJI Pilot.
- b. When the above conditions are not met, the aircraft will directly land after RTH is triggered.
5. The aircraft will return to the Home Point, and Landing Protection* will be triggered to allow the aircraft to land or hover in place. Refer to Landing Protection Function for details.

* Make sure that the Downward Vision Positioning is enabled in the DJI Pilot app.

Use the Smart RTH for example:

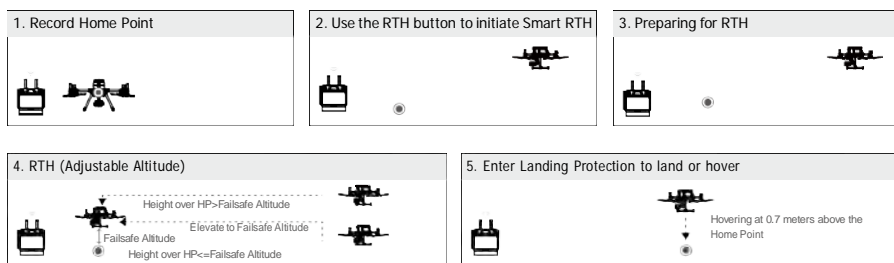

Failsafe Safety Notices

| | |
|--|--|
| | <p>The aircraft cannot avoid obstacles during Failsafe RTH when the Forward Vision System is disabled. Therefore, it is important to set a suitable Failsafe altitude before each flight. Launch the DJI Pilot app, enter Camera and tap to set the Failsafe Altitude.</p> |
| | <p>If the aircraft is flying under 65 feet (20 meters) and Failsafe (including Smart RTH, Lower Battery RTH) is triggered, the aircraft will first automatically ascend to 65 feet (20 meters) from the current altitude. You can only cancel the ascending by exiting the Failsafe.</p> |
| | <p>The aircraft automatically descends and lands if RTH is triggered when the aircraft flies within a 65-foot (20 meter) radius of the Home Point and the aircraft height is less than 30 m. The aircraft will stop ascending and immediately return to the Home Point if you move the left stick when the aircraft is flying at an altitude of 65 feet (20 meters) or higher and Failsafe is triggered.</p> |
| | <p>The aircraft cannot return to the Home Point when GPS signal is weak ([] displaying less than three bars) or is unavailable.</p> |

Obstacle Avoidance During RTH

The aircraft can sense and actively attempt to avoid obstacles during RTH, provided that lighting conditions are adequate for the Forward Vision System. Upon detecting an obstacle, the aircraft will act as follows:

1. The aircraft decelerates when an obstacle is sensed at approx. 65 feet (20 meters) ahead.
2. The aircraft stops and hovers then starts ascending vertically to avoid the obstacle. Eventually, the aircraft will stop climbing when it is at least approx. 16 feet (5 meters) above the detected obstacle.
3. RTH procedure resumes. The aircraft will continue flying to the Home Point at the current altitude.

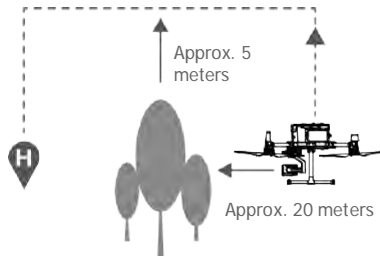

- Obstacle Sensing is disabled during RTH descent. Proceed with care.
- To ensure the aircraft returns home forwards, it cannot rotate during RTH while the Vision System is enabled.
- The aircraft cannot avoid obstacles beside or behind it.

Landing Protection Function

Landing Protection will activate during auto-landing.

1. Landing Protection determines whether the ground is suitable for landing. If so, the aircraft will land smoothly.
2. If Landing Protection determines that the ground is not suitable for landing, the aircraft will hover and wait for pilot confirmation. The aircraft will hover if it detects the ground is not appropriate for landing even with a critically low battery warning. Only when the battery level decreases to 0% will the aircraft land. Users retain control of aircraft flight orientation.
3. If Landing Protection is inactive, the DJI Pilot app will display a landing prompt when the aircraft descends below 0.7 meters. Tap to confirm or pull down the control stick for 2 seconds to land when the environment is appropriate for landing.



Landing Protection will not be active in the following circumstances:

- When the user is controlling the pitch/roll/throttle sticks (Landing Protection will re-activate when the control sticks are not in use)
- When the positioning system is not fully functional (e.g. drift position error)
- When the downward vision system needs re-calibration
- When light conditions are not sufficient for the downward vision system
- If an obstacle is within one meter of the aircraft, the aircraft will descend to 0.7 m above the ground and hover. The aircraft will land after user confirmation.

Center of Gravity Calibration

The center of gravity will shift when the aircraft's payloads change. To ensure stable flight, it is required to recalibrate the aircraft's center of gravity when a new payload is installed.



- Calibrate in a windless environment. Make sure that the aircraft is hovering and there is a strong GNSS signal during calibration.
- Maintain visual line of sight of the aircraft and pay attention to flight safety.

Calibration instructions: Go to Flight Controller Settings in the app, and tap Calibrate in the Center of Gravity Auto Calibration section. The Aircraft Status Indicators will glow solid purple during calibration. There will be a prompt in the app after calibration is completed.

Flight Recorder

Flight data is automatically recorded to the internal storage of the aircraft. You can connect the aircraft to a computer via the USB port and export this data via DJI Assistant 2 or DJI Pilot app.

Propellers

Propellers Usage Guide

M300 RTK uses the 2110 propeller. The 2195 propeller is purpose-built to improve the aircraft's maximum flight altitude while maintaining minimal flight noise.

Flight altitude limit is the maximum height that the aircraft can fly normally where the wind speed should not exceed 12 m/s. Note that the aircraft's braking and acceleration capabilities are reduced near to the flight altitude limit. Please read the diagram below to learn more about using the appropriate propellers by referring to the aircraft's weight and the expected maximum flight altitude.

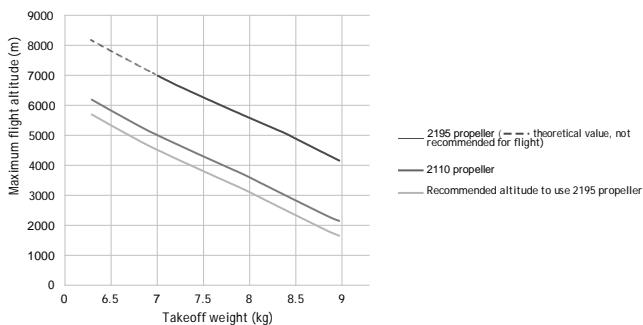

- Using the 2195 propellers for extended periods will reduce the motor life.
- Only use DJI approved propellers. DO NOT mix propeller types.
- Ensure to check that the propellers and motors are installed firmly and correctly before each flight.
- Ensure that all propellers are in good condition before each flight. DO NOT use aged, chipped, or broken propellers.
- To avoid injury, stand clear of and DO NOT touch propellers or motors when they are spinning.

Replacing the Propellers

In order to replace the propellers, use the H2.5 hex key with ball-end.

It is recommended to replace the propellers only in an emergency situation during operations. After the emergency flight is over, please contact DJI technical support or an authorized agent for overhaul as soon as possible.

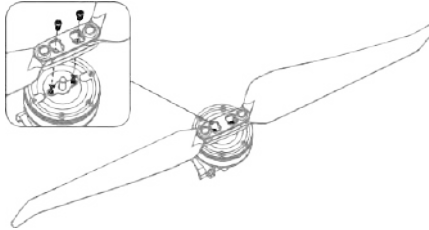

 Propeller blades are sharp; please handle with care.

Intelligent Battery Station

The Battery Station features a total of 12 battery ports and can charge up to eight TB60 Intelligent Flight Batteries, and four WB37 Intelligent Batteries. It also comes built in with integrated wheels that make the Battery Station easy to maneuver from one place to another.

Warnings

1. Keep any liquids (oil, water etc.) away from the inside of the Battery Station.
2. DO NOT close the Battery Station during charging or discharging, and ensure it is well ventilated and able to dissipate heat.
3. The Battery Station is only compatible with the TB60 Intelligent Flight Battery, and WB37 Intelligent Battery. DO NOT use the Battery Station with any other battery models.
4. Place the Battery Station on a flat and stable surface when in use. Ensure the device is properly insulated to prevent fire hazards.
5. DO NOT touch the metal terminals on the Battery Station. If there is any noticeable debris buildup, wipe the metal terminals with a clean, dry cloth.
6. Take care to avoid injuring fingers when opening or closing the Battery Station, or using the retractable trolley handle.
7. Place the batteries in the specified directions.
8. Air pressure in the Battery Station may change during air transportation or after extreme barometric pressure changes. The pressure valve knob on the side of the Battery Station will balance the air pressure automatically.
9. Please use the dust blower to clear the sand and dust in the Battery Station.

Overview

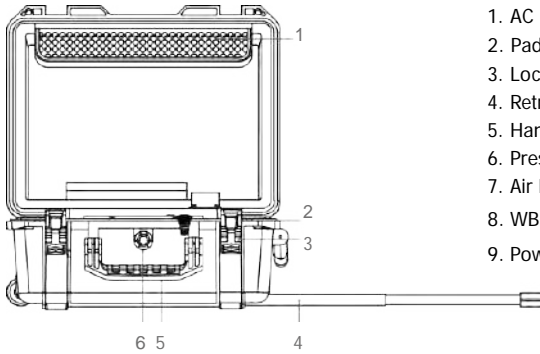

- 1. AC Power Cable Slot
- 2. Padlock Holes
- 3. Locks
- 4. Retractable Trolley Handle
- 5. Handles
- 6. Pressure Valve
- 7. Air Intake
- 8. WB37 Battery Port
- 9. Power Port

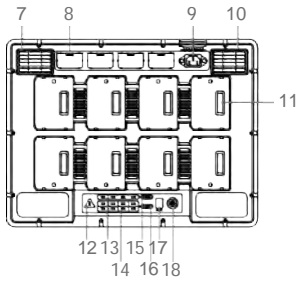

- 10. Air Vent
- 11. TB60 Battery Port
- 12. Warning LED
- 13. WB37 Battery Status LEDs
- 14. TB60 Battery Status LEDs
- 15. WB37 Charging Status LEDs
- 16. TB60 Charging Status LEDs
- 17. Firmware Update Port (USB-C)
- 18. Power Button / Power Indicator

Activation

Use DJI Pilot app and follow the instructions below to activate the Battery Station.

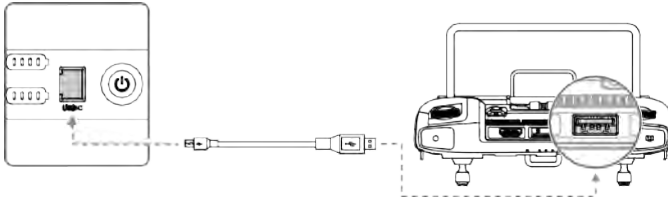

1. Connect the Battery Station to a power outlet and press the Power Button to turn on the Battery Station. Connect the Battery Station to the remote controller using a USB-C cable.
2. Turn on the remote controller and run the DJI Pilot app.
3. Follow the app instructions to activate the Battery Station.

Using the Battery Station

Charging

1. Connect the Battery Station to a power outlet (100-120 Vac, 50-60 Hz / 220-240 Vac, 50-60 Hz) via the AC power cable.

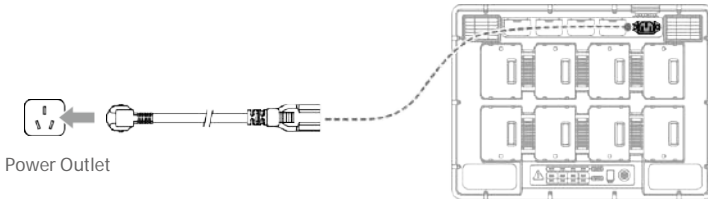

2. Press the Power Button once to turn on the Battery Station.
3. Insert the batteries into the Battery Ports to start charging.
 - a. With a 100-120 V input, it takes about 70 minutes to fully charge the TB60 battery, and 40 minutes to charge from 20% to 90% battery level.
 - b. With a 220-240 V input, it takes about 60 minutes to fully charge the TB60 battery, and 30 minutes to charge from 20% to 90% battery level.



- For TB60 Intelligent Flight Batteries, the Battery Station will charge the two batteries with the most amount of remaining battery power first. For example, if there are four TB60 batteries plugged into the Battery Station (the first two batteries have 10% remaining battery power and the second two batteries have 30% remaining battery power), the Battery Station will automatically charge the batteries with the highest remaining battery power first.
- For WB37 Batteries, the Battery Station will charge the battery with the highest remaining battery power first.
- When the temperature of the battery is too low, it will warm up automatically before charging.



-  • Refer to the “Battery Station LEDs Description” for more information about the various LEDs.
- DJI does not take any responsibility for damage caused by third-party chargers.
- To ensure safety, discharge the battery before transporting the aircraft. Fly the aircraft outdoors until its power level ranges within 30% to 20%.
- The battery has a capacity of 274 Wh. Please follow the regulations and guidelines for traveling with these batteries via air.

Warming up and Charging in Low Temperature

When the temperature falls between -20°C to 5°C, the Battery Station will warm up the battery before charging it.

-  DO NOT charge the battery frequently in low-temperature environments, as the charging time becomes longer, and the battery life may be shortened.

Battery Station LEDs Description

| LED Indicators | Descriptions |
|--|--|
| Power Indicator | |
| Solid green | Powered on. |
| Battery Status LEDs  | |
| Solid green | Charging completed. |
| Blinks green | Charging. |
| Solid yellow | Waiting for charging. |
| Blinks yellow | Warming up before charging. |
| Blinks yellow twice | Cooling down before charging. |
| Blinks yellow three times | Cannot charge the battery due to very low temperature. Please charge the battery in the place of higher temperature. |
| Solid red | Battery error. * |
| Blinks red | Battery communication warning, please try other battery ports. |
| Blinks red twice | Battery short circuit, please try other battery ports. |
| Warning LED  | |
| Blinks yellow | Battery Station is updating. |
| Solid yellow | The input voltage is too low. Please use the power supply that meets the requirements. |
| Blinks red | Power module communication error or other. * |
| Blinks red twice | Motherboard error. * |
| Blinks red three times | Fan error. * |
| Blinks red four times | Battery Station self-test error. * |

For errors marked with *, please contact your local dealer or a representative from the DJI after-sales team.

Buzzer Beeping Description

Buzzer beeping is used to indicate errors as outlined below.

1. When the Battery Status LED is red, the buzzer is beeping to indicate a battery error.
2. When the Warning LED is red, the buzzer is beeping to indicate a Battery Station hardware error.

Specifications

| | |
|-------------------------|--|
| Model | BS60 |
| Dimensions | 501 × 403 × 252 mm |
| Net Weight | 8.37 kg |
| Max Internal Load | 12 kg |
| Compatible Stored Items | TB60 Intelligent Flight Battery × 8 WB37 Intelligent Battery × 4 AC Power Cable |
| Input | 100-120 Vac, 50-60 Hz / 220-240 Vac, 50-60 Hz |
| Output | TB60 Intelligent Flight Battery Port: 52.8 V, 7 A×2 @100-120 V, 8.9 A×2 @220-240 V WB37 Intelligent Battery Port: 8.7 V, 6 A |
| Output Power | 100-120 V, 750.0 W 220-240 V, 992.0 W |
| Power without Load | < 8 W |
| Warming up the battery | 52.8 V, 2 A |
| Operating Temperature | -20°C to 40°C (-4° F to 104° F) |
| Charging Time* | 100-120 V, 70 min 220-240 V, 60 min |
| Protection Features | Anti-backflow Protection Short Circuit Protection Over Voltage Protection Over Current Protection Temperature Protection |

* Charging times are tested in a lab environment at room temperature. The values provided should be used for reference only.

Battery Station Firmware Update

Use the DJI Pilot App to update firmware of the Battery Station as well as up to 8 TB60 flight batteries at the same time.

1. Insert the batteries into the Battery Ports and turn on the Battery Station.
2. Connect the Battery Station to the remote controller using a USB-C cable.

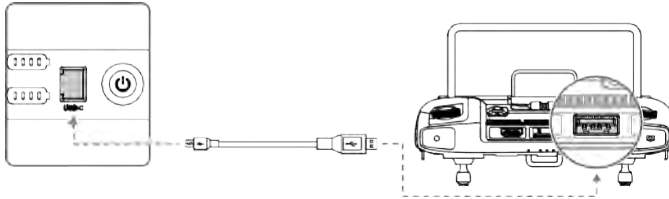

3. Turn on the remote controller and make sure it is connected to the Internet.
4. Run the DJI Pilot app, tap to enter PILOT page. If it shows that there is a firmware update for the Battery Station, then tap into the HMS page.
5. Tap to enter the firmware update page.
6. Tap the update all button and wait for about 10 minutes to complete the firmware upgrade.

-
- ⚠ • During firmware update, do not insert or remove the battery to avoid battery update failure.
- During firmware update, do not unplug the USB-C cable to avoid battery update failure.
 - During firmware update, do not charge the battery station.

Intelligent Flight Battery

Battery Introduction

The TB60 Intelligent Flight Battery has high-energy cells, and a smart charge/discharge functionality. It should only be charged using appropriate DJI approved chargers. The Intelligent Flight Battery must be fully charged before using it for the first time. The battery firmware is included in the aircraft firmware. Make sure that all the batteries' firmware is up-to-date.

DJI Intelligent Flight Battery Functions

1. **Battery Level Display:** The LED indicators display the current battery level.
2. **Charge or discharge the battery to 40% – 60% if NOT intended to be used for 10 days or more.**
This can greatly extend the battery's overall life span. It takes approximately 6 days to discharge the battery to 60%. It is normal that you may feel moderate heat emitting from the battery during the discharge process. You can set the discharging thresholds in the DJI Pilot app.
3. **Balanced Charging:** Automatically balances the voltage of each battery cell when charging.
4. **Overcharge Protection:** Charging automatically stops when the battery is fully charged.
5. **Temperature Detection:** The battery will not be charged to avoid damage when the battery temperature is lower than -20 °C (-4°F) or higher than 45°C (113°F).
6. **Over Current Protection:** The battery stops charging when a high amperage is detected.
7. **Over Discharge Protection:** Over-discharging can seriously damage the battery. Current output will be cut off when the battery cell is discharged to 3.2 V when not in flight mode. For extended flight times, over-discharging protection is disabled as batteries discharge during flight. In this instance, a battery voltage below 1.8 V may cause a safety hazard such as a fire when charged. To prevent this, the battery will not be able to charge if the voltage of a single battery cell is below 1.8 V. Avoid using any batteries matching this description and avoid serious over-discharging to prevent permanent battery damage.
8. **Short Circuit Protection:** Automatically cuts the power supply when a short circuit is detected.
9. **Battery Cell Damage Protection:** DJI Pilot displays a warning message when a damaged battery cell is detected.
10. **Sleep Mode:** Sleep mode is entered to save power when the aircraft is not flying.
11. **Communication:** Information pertaining to the battery's voltage, capacity, current, etc. is transmitted to the aircraft's main controller.
12. **Heating:** Batteries are able to work even in cold weather, ensuring a safe flight.
13. **Waterproof and Dustproof:** The aircraft has an IP45 Protection Rating , with the batteries installed.



Refer to the Disclaimer and Intelligent Flight Battery Safety Guidelines before use. Users take full responsibility for all operations and usage.

Installing the Batteries

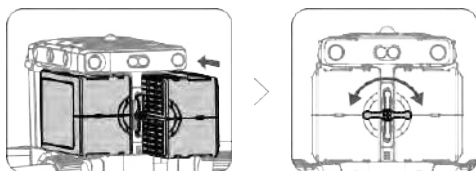

Pairing Batteries

Before first use, it is recommended to mark 2 batteries as a pair and continue using them as a pair (charge and discharge them together) to maximize service life and ensure flight performance. If two batteries with a significant difference in battery life are installed and powered on, a prompt will pop up in the app to recommend that you replace the batteries to a pair with similar performance.

Turning On / Off

The battery can only be turned on and off after it is installed on the aircraft.

Turning On: Press the Power button once, then press again and hold for 3 seconds to turn on. The Power LED will turn green and the Battery Level Indicators will display the current battery level.

Turning Off: Press the Power button once, then press again and hold for 3 seconds to turn off. The Power LED and the Battery Level Indicators will be off.

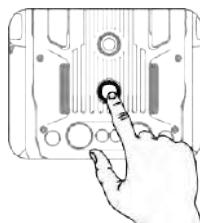

Replacing the Batteries When Turned On

If the battery needs to be replaced immediately after landing, you can replace it without turning off the aircraft. Replace with one fully charged battery, and wait for 3 seconds, and then replace another battery.

Heating the Battery

Manual Heating: If the Intelligent Flight Battery is not installed into the aircraft, press and hold the battery level button on the battery for four seconds to initiate the self-heating, keeping the batteries at a temperature between 61° F (16° C) and 68° F (20° C), which is the ideal range of operating temperature, for approximately 30 minutes. Press and hold the battery level button for two seconds to stop heating.

Auto Heating: Insert the batteries into the aircraft and power it on. If a low battery temperature is detected, the battery will automatically heat up to maintain a temperature between 61° F (16° C) and 68° F (20° C).

Low Temperature Notice:

1. The performance of the intelligent Flight Battery is significantly reduced when flying in low temperature environments (temperatures below 5°C). Ensure that the battery is fully charged and the cell voltage is at 4.4 V before each flight.
2. End the flight as soon as DJI Pilot displays the “Low Battery Level Warning” in low temperature environments. You will still be able to control the aircraft’s movement when this warning is triggered.
3. In extremely cold weather, the battery temperature may not be high enough even after warming up. In

these cases, insulate the battery as required.

4. To ensure optimal performance of the battery, keep the battery temperature above 16°C.
5. In low temperature environments, it will take a longer time for the batteries to warm up. It is recommended to keep the battery warm before use to reduce the warm-up time.



Checking Battery Levels

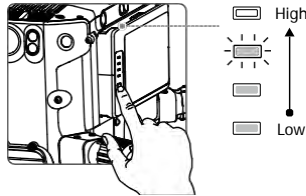































When the battery is turned off, press the Battery Level button once and the Battery Level Indicators will display the current battery level.



Battery Level Indicators display how much power remains. When the battery is turned off, press the Power button once and the Battery Level Indicators will display the current battery level. See below for details.

 The Battery Level Indicators will also show the current battery level during discharging. The indicators are defined below.

 : LED is on.  : LED is off.  : LED is flashing.

| Battery Level | | | | |
|---|---|---|---|---------------|
| LED1 | LED2 | LED3 | LED4 | Battery Level |
|  |  |  |  | 88%~100% |
|  |  |  |  | 75%~88% |
|  |  |  |  | 63%~75% |
|  |  |  |  | 50%~63% |
|  |  |  |  | 38%~50% |
|  |  |  |  | 25%~38% |
|  |  |  |  | 13%~25% |
|  |  |  |  | 0%~13% |

D-RTK

Introduction

The aircraft has a built-in RTK, which can withstand magnetic interference from metal structures, ensuring stable flight. More accurate positioning data can be achieved when using a DJI D-RTK 2 High Precision GNSS Mobile Station.

Enable / Disable RTK

Ensure that the "Aircraft RTK" is enabled and RTK service type is correctly set (D-RTK 2 Mobile Station) before each use. Go to Camera View in the app >>> RTK to view and set. Make sure to disable RTK function if not in use. Otherwise, the aircraft will not be able to take off when there is no differential data.

Using the DJI D-RTK 2 Mobile Station

1. Refer to the D-RTK 2 Mobile Station User Guide to complete linking between the aircraft and the mobile station, including setup.
2. In the RTK Settings page in the app, select the RTK service type as "D-RTK 2", connect the mobile station by following the instructions, and wait for the system to start searching for satellites. In the RTK Settings page, the status of the aircraft's positioning in the status table will show "FIX" to indicate that the aircraft has obtained and used the differential data from the mobile station.
3. D-RTK 2 Mobile Station range: 12 km (CC / FCC), 6 km (SRRC / CE / MIC).

Using the Custom Network RTK

You can mount a Dongle to the remote controller or use the app to connect to a Wi-Fi, and enable Internet network to use the Custom Network RTK. Custom Network RTK can be used to replace the RTK base station. Connect the Custom Network RTK account to the designated Ntrip server to send and receive differential data. Keep the remote controller turned on and the Internet network connected.

1. Make sure the remote controller and the aircraft are linked, and the app is connected to the Internet network.
2. Go to Camera View in the app >>>> RTK, select the RTK service type as "Custom Network RTK", fill in the Ntrip's host, port, account, password, mount point, and then tap to set by following the instructions.
3. Wait to connect to the Ntrip server. In the RTK Settings page, the status of the aircraft's positioning in the status table will show "FIX" to indicate that the aircraft has obtained and used the differential data from the mobile station.

DJI AirSense

Airplanes and helicopters with an ADS-B transceiver will actively broadcast flight information including location, flight path, speed, and altitude. DJI AirSense receives this by ADS-B transceivers via an on-board receiver or internet connection. UAVs installed DJI AirSense can obtain the position, orientation and velocity information from the manned airplane built-in ADS-B transmitter (1090 ES and UAT standard supported), calculate the collision risk level real time and send the warning to user. The system will analyze the potential risk of collision by comparing the location of an airplane or a helicopter, sending timely warnings to pilots via the DJI Pilot app.

DJI AirSense provides users with information about nearby airplanes and helicopters to ensure flight safety. The system doesn't actively control the drone to avoid incoming airplanes or helicopters. Always fly your aircraft within a visual line of sight and be cautious at all times. Lower your altitude when you receive warnings. Please be aware that DJI AirSense has the following limitations:

1. It can only receive messages sent by airplanes and helicopters installed with an ADS-B out device and in accordance with 1090ES (RTCA DO-260) or UAT (RTCA Do-282) standards. DJI devices will not receive related broadcast messages or send out warnings for airplanes or helicopters without ADS-B outs or with malfunctioning ADS-B outs.
2. If there is an obstacle or steel structure between airplanes or helicopters and DJI aircraft, the system won't be able to receive ADS-B messages sent by airplanes or helicopters or send out warnings. Keenly observe your surroundings and fly with caution.
3. Warnings may be sent with delay when the DJI AirSense is interfered by the surrounding. Keenly observe your surroundings and fly with caution.
4. Warnings are not sent when a DJI aircraft is unable to determine its location.
5. It cannot receive ADS-B messages sent by airplanes or helicopters or send out warnings when disabled or misconfigured.

On the precondition that connection between a DJI aircraft and the pilot remote controller is stable, when the system confirms the possibility of a collision, it will send a series of warnings based on the distance between drone and airplanes or helicopters. We recommended that the operator descend altitude immediately after the first warning to avoid a collision, choosing another flight path where necessary.

Warning Escalation:

The first (or "lowest") level warning occurs when the manned aircraft is detected. All detected aircraft will be displayed in the app (up to 10 aircraft at a time). Please pay attention to ensure flight safety.

The second (or "middle") level warning occurs two kilometers away from the manned aircraft. Please pay attention to avoid any hazard ds.

The third (or "highest") level warning occurs one kilometer away from the manned aircraft. Please avoid the manned aircraft immediately.



Blue: The first level warning



Yellow: The second level warning



Red: The third level warning

Expansion Ports

The M300 RTK offers several SDK expansion ports on the top and bottom of the aircraft. These expansion ports enable developers to explore more possibilities and functions with the aircraft. For more detailed information, visit <https://developer.dji.com/>.

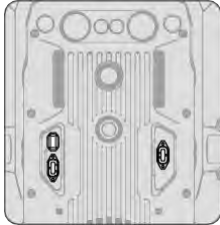

Top view

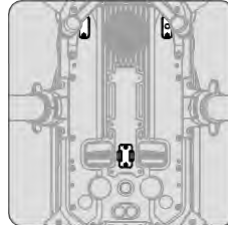

Bottom view



M300 RTK supports three PSDK ports and one OSDK port. The external power supply capacity of the PSDK port is 17.0 V / 13.6 V 4 A. The external power supply capacity of OSDK port is 24 V 4 A. These four SDK ports incorporate a power limit of 180 W.

IP45 Protection Rating

Under stable laboratory conditions, the M300 RTK achieves an IP45 protection rating by IEC60529 standards when equipped with TB60 Intelligent Flight Batteries. However, this protection rating is not permanent and may reduce over time after long-term use.

- DO NOT fly when the amount of rainfall exceeds 100 mm / 24 h.
- DO NOT fold the frame arms in the rain.
- Make sure the battery ports, battery compartment ports, battery surfaces, and battery compartment surfaces are dry before inserting the batteries.
- Make sure the battery ports and battery surfaces are free from any liquid before charging the batteries.
- Before packing the aircraft into the carrying case, ensure that it is free from any liquid by wiping it carefully.
- Product warranty does not cover water damage.

The aircraft does not achieve IP45 protection rating in the following circumstances:

- Folded frame arms.
- You use batteries other than the M300 RTK's TB60 Intelligent Flight Batteries.
- The cover for the ports are not attached correctly.
- The waterproofing top shell plug is not firmly attached to the top shell.
- The aircraft is broken due to various reasons, such as broken aircraft shell, failure of the waterproof adhesive, etc.

Remote Controller

This section describes the features of the remote controller that includes aircraft and remote controller operations.

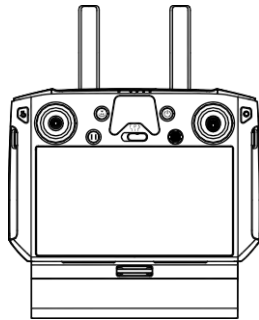

Remote Controller

Profile

The DJI Smart Controller Enterprise (hereinafter referred to as "Smart Controller") features OcuSync Enterprise technology, capable of controlling aircraft that supports this technology, and providing a live HD view from the aircraft's camera. It can transmit image data at distances of up to 9.32 mi (15 km) and comes with a number of aircraft and gimbal controls as well as some customizable buttons. *

The built-in 5.5-inch high brightness 1000 cd/m² screen has a resolution of 1920×1080 pixels, featuring an Android system with multiple functions such as Bluetooth and GNSS. In addition to supporting Wi-Fi connectivity, it is also compatible with other mobile devices for more flexible usage. The Smart Controller has a maximum working time of 2.5 hours with the built-in battery. When using the WB37 Intelligent Battery, the maximum working time can be extended to 4.5 hours. **

* The Smart Controller can reach maximum transmission distance (FCC) in an unobstructed area with no electromagnetic interference at an altitude of about 400 feet (120 meters). The actual maximum transmission distance may be less than the distance mentioned above due to interference in the operating environment, and the actual value will fluctuate according to the strength of interference.

** Maximum operating time is estimated in a lab environment at room temperature, for reference only. When the Smart Controller is powering other devices, the run time will be reduced.

-
- ☒ • **Compliance Standards:** The remote controller is compliant with local laws and regulations.
 - **Stick Mode:** Controls can be set to Mode 1, Mode 2, or to a custom mode.

-
- ⚠ • **Do NOT** operate more than three aircraft within the same area (roughly the size of a soccer field) to prevent transmission interference.

Preparing the Remote Controller

Charging

Charging the Remote Controller

When turned off (using the standard USB charger at room temperature), it takes approximately 2 hours and 15 minutes to fully charge the Smart Controller.

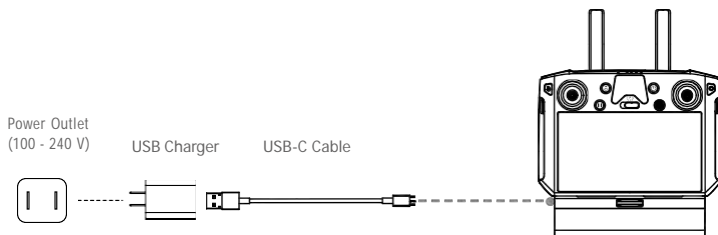

-
- ⚠ • Please use the official USB Charger to charge the Smart Controller. When a standard USB Charger is not available, it is recommended to use an FCC / CE certified USB power adapter rated 12 V / 2 A.
 - Please recharge the battery at least every three months to prevent over discharging - the battery will deplete when stored for an extended period.

External Battery

1. Connect the Battery Station to a power outlet (100-120 Vac, 50-60 Hz / 220-240 Vac, 50-60 Hz).
2. Press the Power Button once to turn on the Battery Station.
3. Insert the batteries into the Battery Ports to start charging. The Battery Station will charge the battery with the highest remaining battery power first.

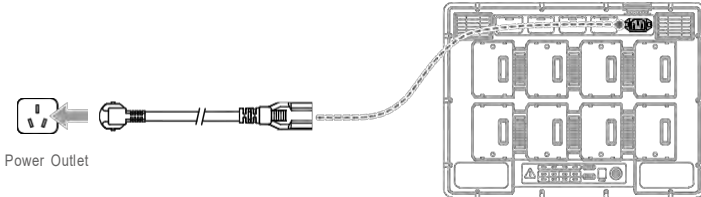

Mounting the WB37 Intelligent Battery

- ① Press and hold the battery release button.
- ② Insert the Intelligent Battery into the battery compartment. Make sure the bottom of the battery is aligned to the marking line in the compartment.
- ③ Push the battery to the bottom.

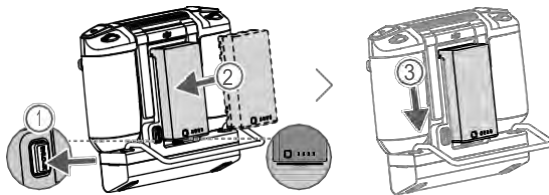

To remove the Intelligent Battery, press and hold the battery release button, then push the battery upward.

Mounting the 4G Dongle and SIM Card



- Only use a DJI-approved dongle.
- The dongle and SIM card enable the Smart Controller to access 4G network. Make sure to deploy these correctly, otherwise, network access will not be available.
- The dongle and SIM card are excluded.

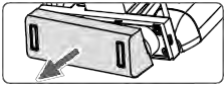

Remove the dongle compartment cover.

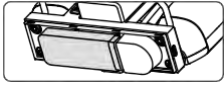

Insert the dongle into the USB port with the SIM card inserted into the dongle.

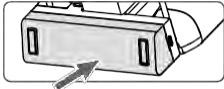

Reattach the cover firmly.

Adjusting the Antennas

Lift the antennas and adjust them. The strength of the Smart Controller signal is affected by the position of the antennas. When the angle between the antennas and the back of the Smart Controller is 80° or 180°, the connection between the Smart Controller and aircraft can reach its optimal performance.

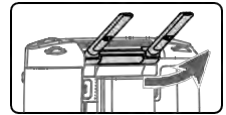

Installing Other Mobile Devices

For other mobile devices (e.g. iPhones, iPads), the Screen Mounting Bracket and an appropriate USB cable are required.

Mounting the Screen Mounting Bracket

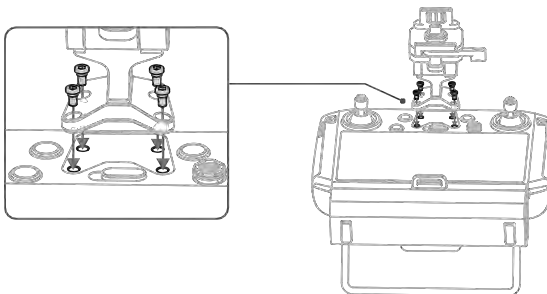

Mounting the Mobile Device

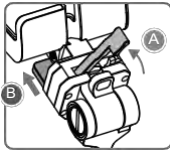

Ensure that Part B is unlocked. Connect Part B to Part A.

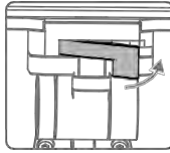

Lock the Mounting Bracket.

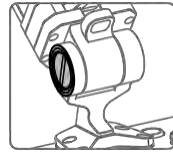

Use a coin or the screwdriver included to adjust the tightness of the tilt axis.

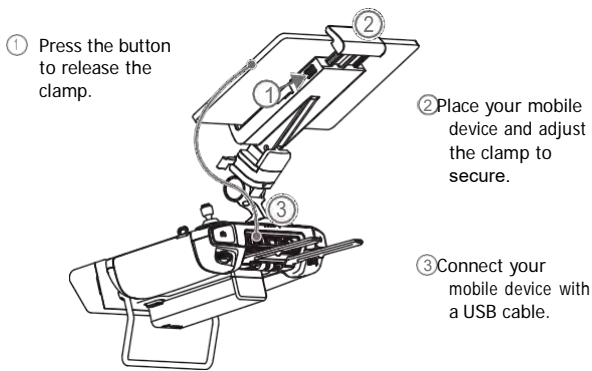

① Press the button to release the clamp.

② Place your mobile device and adjust the clamp to secure.

③ Connect your mobile device with a USB cable.

Attaching the Control Sticks

Follow the steps below to attach the control sticks to the remote controller.

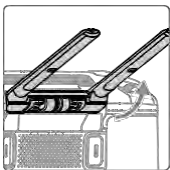

Lift the antennas

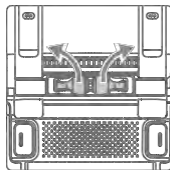

Remove the control sticks

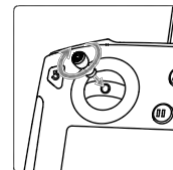

Rotate to attach the control sticks



The control sticks can be stored in the sticks storage slot on the back of the remote controller.

Remote Controller Operations

Checking the Battery Level and Turning On

Checking the Internal Battery Level

Check the internal battery level according to the Battery Level LEDs. Press the power button once to check it while turned off.

Press the power button once, press again and hold for a few seconds to turn on / off the Smart Controller.

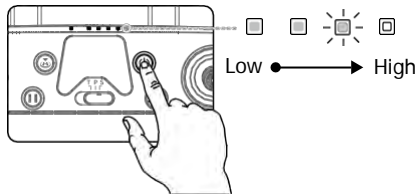

- When using external WB37 Intelligent Battery, it is still necessary to make sure that the internal battery has some power. Otherwise, the Smart Controller cannot be turned on.
- Once the remote control cannot be shut down normally, press and hold the power button for at least 8 seconds, the remote control will be forced to shut down.

Checking the External Battery Level

Method 1: Press the button of the external battery, the battery level is presented in the form of LED lights.

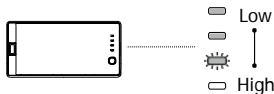

Method 2: Check the percentage of the battery level in the status bar of the main page of the remote controller.

Charging and Discharging Description

Charging

- The remote controller is not activated, the internal battery can only reach up to 60% battery level, and after activation, it can reach 100%.
- The internal battery of the remote controller currently supports charging by the standard charger and external battery (WB37).
- When the external battery is used independently for charging, the internal battery can be charged up to 50%.
- When the working temperature is different, the charging speed varies.

Discharging

- a. When the charger and external battery are connected at the same time, the charger supplies power to the remote controller.
- b. When only the external battery is connected, the external battery will supply power to the remote controller. However, once the external battery is exhausted, the internal battery will supply power.

Linking

When the Smart Controller is purchased together with an aircraft, the remote controller has already been linked to the aircraft, and they can be directly used after activating the remote controller and aircraft. If the Smart Controller and the aircraft were purchased separately, follow the steps below to link the remote controller to the aircraft.

Method 1: Using Smart Controller Buttons

1. Power on the remote controller and the aircraft.
2. Press the customizable button C1, C2, and Record button simultaneously. The status LED blinks blue and the controller beeps twice to indicate the linking has started.
3. Press the linking button on the aircraft. The remote controller's status LED will be solid green if the linking is successful.

Method 2: Using DJI Pilot

1. Power on the remote controller and the aircraft. Tap "Pilot" on the homepage and log in using a DJI account.
2. Tap "Enter Device", select "Connect to the aircraft", and follow the prompts to start linking.
3. Select "Enter the Camera View" and tap  in camera view. Scroll to the bottom, tap "Remote Controller Linking" and tap "OK" to confirm.
4. The status LED blinks blue and the remote controller beeps twice to indicate the linking has started.
5. Press the linking button on the aircraft. The remote controller's status LED will be solid green if the linking is successful.

Method 3: Using Quick Settings

1. Power on the remote controller and the aircraft.
2. Swipe down from the top of the screen to open Quick Settings. Tap  to start linking.
3. The status LED blinks blue and the remote controller beeps twice to indicate the linking has started.
4. Press the linking button on the aircraft. The remote controller's status LED will be solid green if the linking is successful.



- Make sure the remote controller is within 1.6 ft (0.5 m) of the aircraft during linking.
 - Make sure the remote controller is connected to the internet when logging in using a DJI account.
-

Operating the Aircraft

Controlling the Aircraft

This section explains how to control the orientation of the aircraft through the remote controller. Control can be set to Mode 1, Mode 2 or Mode 3.

Mode 1

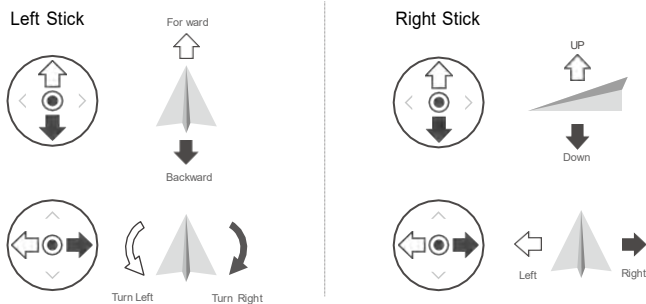

Mode 2

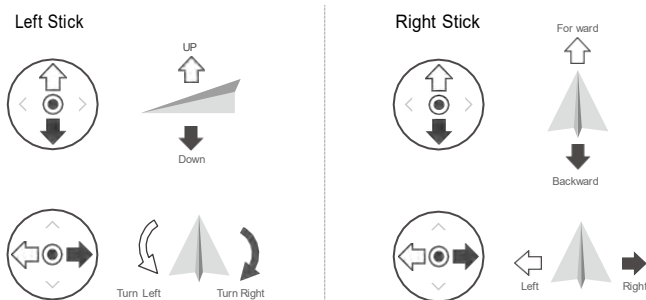

Mode 3

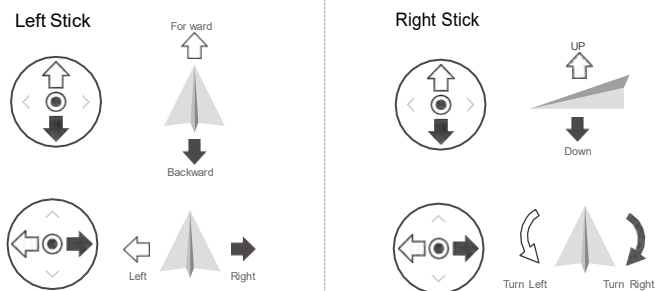







The Stick Mode is set to Mode 2 by default.

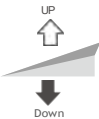

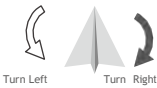
Stick Neutral/Mid-Point: Control sticks are centered.

Moving the Control Stick: Control sticks are pushed away from the center.

| Remote Controller (Mode 2) | Aircraft | Remarks |
|--|---|--|
| <p>Left Stick</p>  |  | <p>Moving the left stick up and down changes the aircraft's elevation. Push the stick up to ascend and down to descend. When both sticks are centered, the aircraft will hover in place. The more the stick is pushed away from the center position, the faster the aircraft will change elevation. Always push the stick gently to prevent sudden and unexpected elevation changes.</p> |
|  |  | <p>Moving the left stick to the left or right controls the rudder and rotation of the aircraft. Push the sick left to rotate the aircraft counter clockwise, and push the stick right to rotate the aircraft clockwise. If the stick is centered, the aircraft will maintain its current orientation. The more the stick is pushed away from the center position, the faster the aircraft will rotate.</p> |
| <p>Right Stick</p>  |  | <p>Moving the right stick up and down changes the aircraft's forward and backward pitch. Push the stick up to fly forward and down to fly backward. The aircraft will hover in place if the stick is centered. Push the stick further away from the center position for a larger pitch angle and faster flight.</p> |
|  |  | <p>Moving the right stick control left and right changes the aircraft's left and right pitch. Push left to fly left and right to fly right. The aircraft will hover in place if the stick is centered. Push the stick further away from the center position for a larger pitch angle and faster flight.</p> |



- Keep the remote controller away from magnetic materials to avoid it being affected by magnetic interference.
- To avoid damage, it is recommended that the control sticks are removed and stored in the storage slot on the remote controller during transportation or storage.

Flight Mode Switch

Toggle the switch to select the flight mode. Choose between T-mode, P-mode, and S-mode.

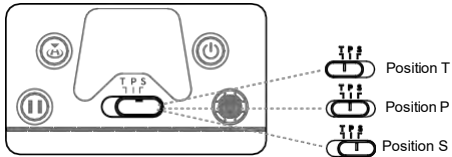

| Position | Flight Mode |
|----------|----------------------|
| T | T-mode (Tripod) |
| P | P-mode (Positioning) |
| S | S-mode (Sport) |

T-mode (Tripod): The aircraft utilizes GNSS and vision systems to locate itself, stabilize, and navigate between obstacles. In this mode, the maximum flight speed is limited to 15.7 mph (25.2 kph). The responsiveness to stick movements is also reduced for smoother, more controlled movement.

P-mode (Positioning): P-mode works best when the GNSS signal is strong. The aircraft utilizes GNSS, Vision Systems, and an Infrared Sensing System to stabilize, avoid obstacles, and track moving subjects. Advanced features such as TapFly and ActiveTrack are available in this mode.

S-mode (Sport): The handling gain values of the aircraft are adjusted to enhance aircraft maneuverability. Note that Vision Systems are disabled in this mode.

Regardless of the position the switch is in on the remote controller, the aircraft begins in P-mode by default. To switch flight modes, first go to camera view in DJI Pilot, tap and enable "Multiple Flight Modes". After enabling multiple flight modes, toggle the switch to P and then to S or T to switch flight modes.

RTH Button

Press and hold the RTH button to start Return to Home (RTH) and the aircraft will return to the last recorded Home Point. Press the button again to cancel RTH and regain control of the aircraft. Refer to the Return to Home section in the aircraft's user manual for more information about RTH.

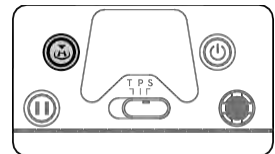

In Advanced Dual Operator Mode, the remote controller without flight control cannot use this button to start and stop the RTH function.

Customizable Buttons

The functions of the C1, C2 and 5D buttons are set in DJI Pilot. The default configurations are as below:

C1: Re-center the gimbal.

C2: To switch the camera view between different cameras.

Rotating the Gimbal Pan Control Dial by holding the Confirm Button: To control the camera zoom.

Optimal Transmission Zone

Try to keep the aircraft inside the optimal transmission zone. If the signal is weak, adjust the antennas or fly the aircraft closer.

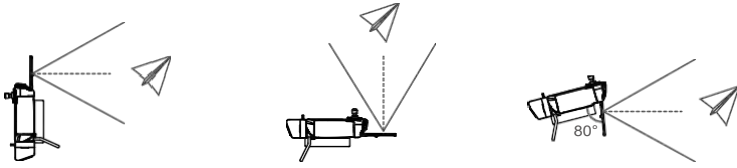

Make sure the antennas are facing towards the aircraft. When the angle between the antennas and the back of the Smart Controller is 80° or 180° , the connection between the remote controller and the aircraft can reach its optimal performance.

Note that the illustrations above do not reflect the actual distances between the user and aircraft and are for reference only.



- Avoid using wireless devices that use the same frequency bands as the Smart Controller.
- In real operation, the DJI Pilot app will issue a prompt to warn that the transmission signal is weak, and please adjust the antennas to ensure that the aircraft is back to the optimal transmission range.

Operating the Camera

Shoot videos and photos with the Focus / Shutter button and Record button on the remote controller.

1. Focus / Shutter Button

Press to take a photo. If Burst mode is selected, multiple photos will be taken if the button is continuously pressed. Set the Shutter mode in DJI Pilot app.

2. Record Button

Press once to start recording video and press again to stop.

Operating the Gimbal

Use the left dial and right dial to adjust the gimbal pitch and pan.

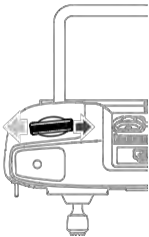

The left dial controls the gimbal tilt. Turn the dial to the right, and the gimbal will shift to point upwards. Turn the dial to the left, and the gimbal will shift to point downwards. The camera will remain in its current position when the dial is static.

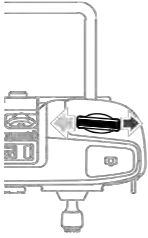

The right dial controls the gimbal pan. Turn the dial to the right, and the gimbal will shift clockwise. Turn the dial to the left, and the gimbal will shift counter clockwise. The camera will remain in its current position when the dial is static.

Advanced Dual Operator Mode

Introduction

The M300 RTK supports Advanced Dual Operator Mode, which allows two remote controllers to connect to the same aircraft. In this mode, two remote controllers are of the same priority and have no pre-assigned roles. During operation, two pilots take control based on their requirements and decide which onboard device such as aircraft, gimbal and camera can be operated currently, making it more flexible to operate.

There are two types of control, including aircraft flight control and gimbal control. For the remote controller with aircraft flight control, it can control the orientation of the aircraft. For the remote controller with gimbal control, it can control the movement of the gimbal and camera operation.

Configuring Advanced Dual Operator Mode

Before use, remote controller A and remote controller B must be linked separately. Follow these steps to complete linking:

Linking the Remote Controller

1. Launch DJI Pilot App.
2. Enter "Camera" and tap on . The remote controller is ready to link.
3. In the drop-down list of Advanced Dual Operator Mode, select remote controller as Controller A or Controller B. Tap the pop-up window to confirm linking.

Using Advanced Dual Operator Mode

1. Ensure two remote controllers have been linked and connected to the aircraft. The first connected remote controller is able to control all devices including aircraft, gimbal and camera by default, while the second one has no control of any device.
2. A remote controller that has control of a device can use a control stick, gimbal dial, button combinations, and UI icon to control the device, which is in line with a single remote controller. Otherwise, the device cannot be controlled. A remote controller that has no control of a device can still switch to the Camera View of the device. Only a remote controller that is able to control the orientation of the aircraft can initiate and cancel the Return to Home (RTH) procedure.
3. Users can take control of devices manually. First, switch to the Camera View of the device that you want to control. For aircraft flight control, switch to the Camera View of the FPV camera. Second, tap on the control icon on the upper left to take control. The 4-axis aircraft icon represents aircraft flight control, and the camera icon represents gimbal control.

4. When a user has aircraft flight control, press and hold the Control Lock icon to lock the aircraft flight control on the Camera page of the FPV camera.
5. If a remote controller can only control the gimbal, it can use control sticks. If a user has both aircraft flight control and gimbal control, he/she can use control sticks to control the orientation of the aircraft, and gimbal dial to control the gimbal.
6. When operating in Dual Remote Control Mode, control switching will be triggered if one remote controller is disconnected to an aircraft. At this point, gimbal control that the disconnected remote controller has will be transferred to the connected controller unconditionally. If the disconnected controller has aircraft flight control, the connected controller will receive takeover prompts and the pilot can decide whether to take over or not. For a negative decision or when a decision is not made within the given time, a failsafe logic will be triggered.
7. During operation, if the disconnected controller reconnects to the aircraft, it has no control of any device by default. Pilots can take control according to their requirements.
8. Settings related to gimbal and camera are only available to the remote controller that has control of gimbal and camera.
9. Functions such as download and playback of gimbal and camera are only available to the remote controller that has control of gimbal and camera.
10. Normally, both remote controllers can configure the flight controller, vision system, video transmission, and Intelligent Flight Battery. However, if aircraft flight control is locked, only the remote controller that has aircraft flight control can perform such configurations.
11. Both remote controllers can perform operations that will not affect flight.
12. Controller B does not support Mission upload for AI Spot-check.
13. Controller A supports one-click upgrade when connecting to the aircraft and gimbal and camera. Controller B only supports remote controller upgrade.
14. Pilot App log upload: Controller A supports uploading Controller A aircraft log and remote controller log, while Controller B only supports uploading Controller B remote controller log.
15. Controller B does not support the upgrade of flight limits database.
16. Users can control the zoom of the camera by using the joystick of the RC with gimbal control.

Video Transmission Descriptions

Matrice 300 RTK aircraft features OcuSync Enterprise technology, supports up to three 1080p video transmissions, and also supports single remote controller mode or dual remote controller mode.

1. Single remote controller mode: supports two 1080p video transmissions.
2. Dual remote controller mode: supports up to three 1080p video transmissions and each remote controller can select two of the video transmissions to display.



Transmission resolution is limited by the output capability of different payloads, for reference only.

- Zenmuse H20 / H20T: 1080p
- FPV Camera: 960p
- Zenmuse Z30: 720p
- Zenmuse XT S: 640p
- Zenmuse XT2: 720p

Display Interface

Homepage

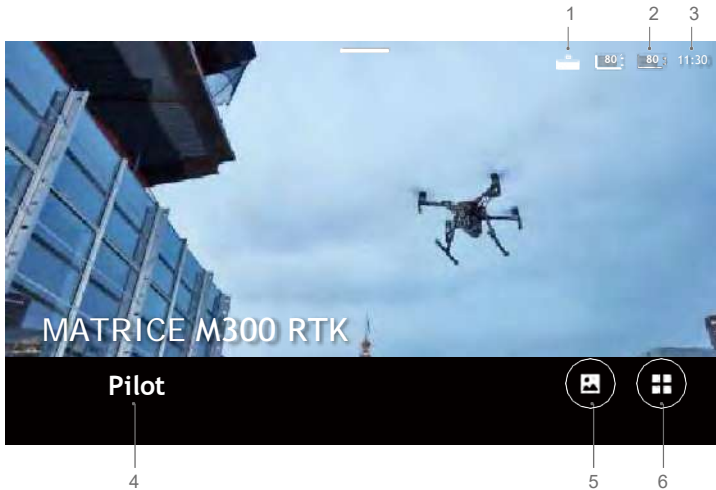

The screen displays the homepage when the Smart Controller is powered on.



- 1. DJI Smart Controller Expansion Kit Connection Status**
Displays when the DJI Smart Controller Expansion Kit is connected.
- 2. Battery Level**
Displays the internal and external battery level of the remote controller.
- 3. Time**
Displays local time.
- 4. DJI Pilot**
Tap to enter DJI Pilot. The button is blue if the remote controller is linked to the aircraft. Users can tap to enter camera view after logging in using a DJI account.
- 5. Gallery**
Tap to check stored images and videos.
- 6. App Center**
Tap to check all applications including GEO Zone, DJI Pilot, Settings, File Manager, and any third-party apps that users have downloaded and installed. Refer to the App Center section for more information.

 Navigate on the remote controller by using the 5D button, the control sticks, or touching the screen. Confirm a selection by pressing the 5D button or touching the screen. Refer to the Control Stick Navigation section for more information.

App Center

Tap  to enter App Center. Users can find default system apps and third-party apps that have been downloaded. Tap  to find the System Settings and GEO Zone.

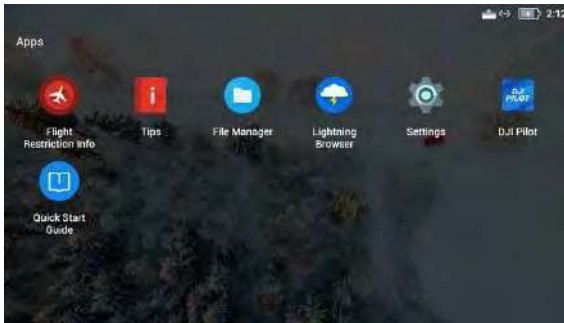

The App Center is subject to change in future

To move an app, hold the icon and move the app to where you wish to place it. To delete the app, hold the icon and drag it to the top of this page. Note that default system apps cannot be deleted.

Flight Restriction Info provides related flight restriction information.

Tips provides basic function introduction, aerial photography tips, view and share instructions.

Manage videos, photos, files and SD card in File Manage.

The system comes with the Lightning Browser.

Press Settings to be able to configure settings such as button combinations, control stick navigation, date & time, languages, Wi-Fi, and Bluetooth.

The remote controller comes with the DJI Pilot app.

Tap Quick Start Guide to read related manuals.



DJI bears no responsibility for the safe use of or compatibility support for third-party apps. If a third-party app is affecting the performance of the Smart Controller, try to delete the third-party apps or reset the Smart Controller to factory settings. To reset the Smart Controller to factory settings, go to Factory Data Reset under Settings.

Quick Settings

Swipe down from the top of the screen to open Quick Settings.

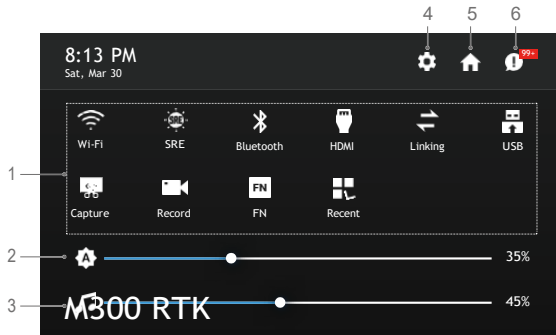

The Quick Settings is subject to change in future

1 Tap an icon to enable or disable the corresponding function. Hold the icon to enter the settings of the function (if available).

: Tap to enable or disable Wi-Fi. Hold to enter settings and connect to or add a Wi-Fi network.

: Tap to enable or disable SRE mode. Hold to enter settings and select an SRE mode.

: Tap to enable or disable Bluetooth. Hold to enter settings and connect with nearby Bluetooth devices.

: Tap to enable or disable the HDMI connection. Hold to enter settings and adjust HDMI resolution, rotation, output mode, and screen zoom.

: Tap to start linking the remote controller to an aircraft.

: Tap to switch between USB external device mode and USB data export mode.

Mobile devices can be connected in the USB external device mode.

Update and data export can be used when the remote controller is connected to a PC in USB data export mode.

: Tap to screenshot the screen.

: Tap to start recording the screen. While recording, the screen displays the recording time. Tap "Stop" to stop recording.

: Hold to check the button combinations.

: Tap to check recently opened apps.

2 Adjusting Brightness

Slide the bar to adjust brightness. The icon means auto brightness. Tap this icon or slide the bar, and the icon will turn to to switch it to manual brightness mode.

3 Adjusting Volume

Slide the bar to adjust the volume. Tap to mute the volume.

4 System Settings

: Tap or hold to enter settings.

5 Homepage

 : Tap to go back to the homepage.

6. Notifications

 : Tap to check system notifications.



- SRE (Sunlight Readable Enhancement) allows users to bump up the highlights or shadows of an image individually or together. This helps users see particular areas of the screen more clearly when sunlight is strong.
- Quick Settings vary depending on the aircraft model linked and the firmware version of the Smart Controller.

Control Stick Navigation

Tap Control Stick Navigation in Settings. Users can enable or disable the control sticks and 5D button to navigate on the remote controller.

Control Sticks: Move up, down, right, or left to navigate. It is not possible to confirm a selection with the control sticks.

5D Button: Push up, down, right, or left to navigate. Press to confirm a selection.







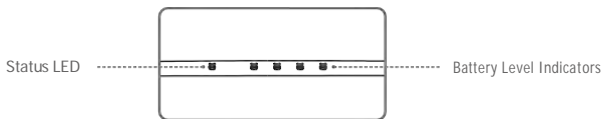











- As the control sticks and 5D button may not be compatible with third-party apps, it is recommended to use the touchscreen to navigate when using third-party apps.
- Control Stick Navigation is not available when the remote controller is linked to an aircraft, even if it is enabled beforehand.

Status LED and Battery Level Indicators Description



The battery level indicators displays the battery level of the controller. The status LED displays the linking status and warnings for control stick, low battery level, and high temperature.

| Status LED | Description |
|---------------|---|
| Solid Red | The remote controller is not linked to an aircraft. |
| Solid Green | The remote controller is linked to an aircraft. |
| Blinks Blue | The remote controller is linking to an aircraft. |
| Blinks Red | The temperature of the remote controller is too high. |
| Blinks Yellow | The battery level of the remote controller is low. |
| Blinks Cyan | The control sticks are not centered. |

| Battery Level Indicators | | | | Battery Level |
|---|---|---|---|---------------|
|  |  |  |  | 75%~100% |
|  |  |  |  | 50%~75% |
|  |  |  |  | 25%~50% |
|  |  |  |  | 0%~25% |

Smart Controller Warning Sounds

In certain scenarios that require a user warning, the Smart Controller will do so by vibrating and/or beeping. When the controller beeps and the status LED is solid green, this error may be related to the aircraft or flight status, and a warning will appear in DJI Pilot. If this error is related to the Smart Controller, the controller's screen will display a warning or alert.

To disable the beeping, power on the remote controller, select "Sound" in Settings, and turn off "Notification volume".

-
-  Some prompts or warning sounds cannot be turned off, such as linking, high temperature alarm, low battery alarm, stick operation mode switching, stick and key power-on self-test alarm, etc.
-

Firmware Update

Using the DJI Assistant 2

1. Make sure the remote controller is powered off, and then connect the remote controller to a computer using a USB cable with dual-A ports.
2. Power on the remote controller. Tap  on USB data export mode.
3. Launch DJI Assistant 2, and log in using a DJI account.
4. Click the DJI Smart Controller Enterprise icon, and then "Firmware Update".
5. Select and confirm the firmware version you want to update.
6. DJI Assistant 2 will download and update the firmware automatically.
7. The remote controller will restart after update.

Using the DJI Pilot App

1. Power on the remote controller and make sure the Internet connection is functioning normally.
2. Launch DJI Pilot App, tap to enter the update page if the app shows that there is an ongoing firmware update.
3. DJI Pilot will download and update the firmware automatically.
4. The remote controller will restart after an update.

-
-  • Make sure the remote controller has more than 20% power before updating.
 • DO NOT disconnect the USB cable during the update when using DJI Assistant 2.
 • The update takes approximately 15 minutes. Make sure the remote controller or the computer is connected to the internet during the update.
-

Button Combinations

Some frequently-used features can be activated by using button combinations. To use button combinations, hold the back button and then press the other button.

Checking the available button combinations

Hold the Back button until the controller vibrates to check button combinations:

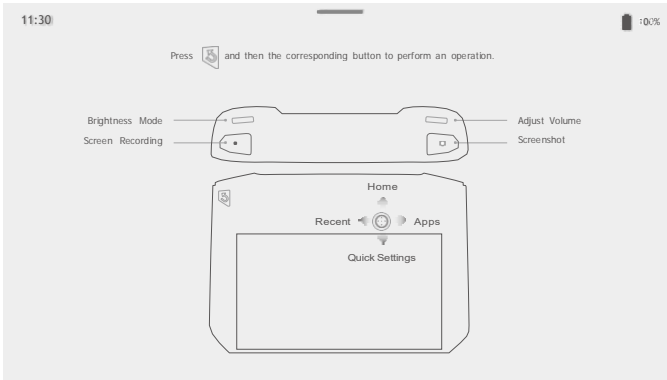

Button Combinations

Using Button Combinations

The functions of the button combinations cannot be changed. The following table displays the function of each button combination.

| Button Combinations | Description |
|--|------------------------------|
| Function Button + Right Wheel | Adjust the system volume |
| Function Button + Left Wheel | Adjust the screen brightness |
| Function Button + Record Button | Record the screen |
| Function Button + Focus/Shutter Button | Screenshot the screen |
| Function Button + 5D Button (up) | Return to Homepage |
| Function Button + 5D Button (down) | Open Quick Settings |
| Function Button + 5D Button (left) | Check recently opened apps |
| Function Button + 5D Button (right) | Open App Center |

Calibrating the Compass

After the remote controller is used in places with electro-magnetic interference, the compass may need to be calibrated. A warning prompt will appear if the remote controller's compass requires calibration. Tap the warning pop-up to start calibrating. In other cases, follow the steps below to calibrate your remote controller.

1. Enter the App Center, tap , and scroll down and tap Compass.
2. Follow the diagram on the screen to calibrate your remote controller.
3. The user will receive a prompt when the calibration is successful.

Blocking Third-party Notifications

To ensure safe flight, we recommend to disable third-party notifications before each flight. Follow the steps below to disable third-party notifications.

1. Enter the App Center, tap , and scroll down and tap Notifications.
2. Enable "Aerial Photography Do Not Disturb Mode".

HDMI

A monitor can display the remote controller's interface by connecting the remote controller to a monitor using a HDMI cable. Follow the steps below to enable the HDMI connection.

1. Swipe down from the top of the screen to open Quick Settings.
2. Follow the diagram on the screen to calibrate your remote controller. Tap HDMI to enable or disable the HDMI connection. Hold to enter settings and adjust HDMI resolution, rotation, output mode, and screen zoom.

Gimbal and Camera

This section focuses on how to use the gimbal.

Gimbal and Camera

M300 RTK supports multiple payload configurations. See the table below for more details.

| Payload combinations | | Gimbal and camera type |
|----------------------|---|---|
| Single gimbal | Single upward gimbal | XT S, Z30, H20, H20T, PSDK payload |
| | Single downward gimbal | XT2, XT S, Z30, H20, H20T, PSDK payload |
| Dual gimbals | Dual downward gimbals | XT2* + Z30, XT2* + H20, XT S + Z30, XT S + H20, above single gimbal type + PSDK payload |
| | Single downward gimbal + Single upward gimbal | |
| Triple gimbals | Dual downward gimbals + Single upward gimbal | The above dual gimbal combinations + PSDK payload |

* XT2 can only be mounted on the 1st gimbal port. It doesn't support upward gimbal/2nd gimbal port.



- Refer to the related gimbal and camera user manual to learn how to use the gimbal and camera.
 - When multiple payloads are used, only one PSDK payload is supported.
-

DJI Pilot App

This section introduces the main functions of the DJI Pilot app.

DJI Pilot App

The DJI Pilot app is specifically developed for enterprise users. Manual flight integrates a variety of professional features that make flying simple and intuitive. Mission flight supports flight planning, and allows you to control the drone automatically, making your workflow much simpler and more efficient.

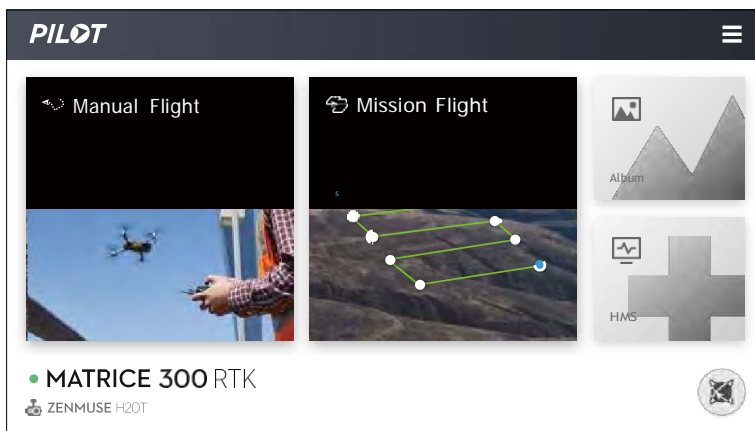

Manual Flight

Camera View

Enter the Camera View by tapping Manual Flight. The descriptions below use a H20T gimbal and camera as an example. The Camera View may vary when using other gimbals and cameras.



1. Back

 : Tap this icon to return to the main menu.

2. System Status Bar

 : This icon indicates aircraft flight status and displays various warning messages.

3. Battery Level Indicator Bar

 : The battery level indicator provides a dynamic display of the battery level. The colored zones on the battery level indicator represent the power levels needed to carry out different functions.

4. Flight Mode

 : The text next to this icon indicates the current flight mode. Tap to configure the Flight Controller settings. These settings allow you to modify flight limits and set gain values.

5. GNSS Signal Strength



 : Shows the current GNSS signal strength. "R" will be displayed on the lower right corner if the aircraft RTK is enabled.

6. Obstacle Sensing Function Status

 : Displays the status for all sensing systems.

If the direction of the corresponding sensing system is working normally, then it is displayed in green, otherwise it is displayed in red. All green indicates that the six-direction sensing system is working normally, and all red indicates that the sensing system is not yet in effect. Please fly carefully.



7. Remote Controller Signal

 : This icon shows the strength of the remote controller signal. The icon will blink when an interference is recognized during flight. When there are no additional warnings in DJI Pilot, it means that the interference will not affect operation and overall flight experience. When in Advanced Dual Operator Mode, this icon will show as 

8. HD Video Link Signal Strength

 This icon shows the strength of the HD video downlink connection between the aircraft and the remote controller. The text on top indicates the frequency in use. Tap for image transmission settings.

9. Battery Settings

 74%  74%  07V : Shows the current battery level. Tap to view the battery information menu, set the various battery warning thresholds, and view the battery warning history.

10. More Settings



Tap  to enter the extended menu to view and adjust the parameters of all other settings.

 : Flight Controller Settings — Includes Flight Mode Switch, Home Point settings, Return to Home altitude, maximum altitude, distance limit, sensors state, remote controller signal lost action, center of gravity auto calibration.

 : Perception Settings — Includes enabling obstacle sensing, vision positioning, and RTH obstacle detection, etc.

 : Remote Controller Settings — Includes stick mode, custom settings, remote controller calibration, linking, etc.

 : Image Transmission Settings — Includes work frequency, channel mode and video output, etc.

-  : Aircraft Battery Settings — Includes low battery warning thresholds, battery information, etc.
-  : Gimbal Settings — Includes gimbal pitch and pan settings, TapZoom magnification (for the Z30 gimbal and camera), gimbal calibration, etc.
- RTK : RTK Settings — Includes RTK positioning function, RTK service type and their corresponding settings.
- : Common Settings — Includes flight route display, units of measurement, live stream, etc.

11. Message Box

 : Tap to read all warning messages.

12. Gimbal Orientation Adjustment

 : Tap to select the Gimbal Orientation Adjustment as Gimbal Recenter, Recenter Gimbal Yaw, Gimbal Yaw Downward or Gimbal Downward.

13. Beacon

 : Tap to turn on / off the beacons. Will change to Discreet Mode icon once turned on.

14. Multiple Gimbal Control

 : Tap to enable Multiply Gimbal Control, you can control two or three gimbals' Pitch and yaw.

15. Smart Track

 : Tap to enable Smart Track. Read the Smart PIN & Track section for more information.

16. PIN Point

 : Tap to record a location. Read the Smart PIN & Track section for more information.

17. Laser Ranging

RNG : Tap to enable Laser Rangefinder. Read the Smart PIN & Track section for more information.

18. Camera and Zoom

 : Displays the current camera and its zoom rate.

19. Camera Parameters

 : Displays the current camera parameters.

20. Focus Mode

 : Tap to Switch the Focus Mode, with MF, AFC and AFS supported.

21. Auto Exposure Lock

 AE : Tap to lock the exposure value.

22. Infrared Camera View Switch Button

 : Tap to switch to infrared camera.

23. Wide Camera View Switch Button

 : Tap to switch to wide camera.

24. Camera View

Displays the current camera view.



25. Zoom Menu

Tap to adjust the camera zoom rate.

26. Gimbal Slider

 : Displays the gimbal tilt angle.

27. Camera Settings

Tap to enter the photo and video settings. Tap  to configure photo settings such as photo mode and image format. Tap  to configure video settings such as video size and format. Tap  to configure video caption, grid and smart LED settings (to enable/disable arm LEDs, beacon LEDs and status LEDs). The settings may vary according to different camera models.

28. Photo / Video Toggle

 : Tap to switch between photo and video recording modes.

29. Shutter / Record Button

 Tap to shoot photos or start/stop recording. Users can also press the Shutter or Record button on the remote controller to shoot photos or record video.

30. Playback

 : Tap to enter Playback and preview photos and videos as soon as they are captured.

31. Parameter Settings

 : Tap to set ISO, shutter, exposure values and other parameters

32. Map

Tap to view the map.

33. Navigaton Display

Displays the aircraft and gimbal orientation, and obstacle avoidance information. Refer to Primary Flight Display (PFD) section for more details.

34. FPV Camera / Gimbal Camera Preview

Without a gimbal and camera, the aircraft can transmit video imagery via the FPV camera.

With a single gimbal and camera, the aircraft can transmit imagery via the FPV camera and the single camera; two views can be displayed.

With dual gimbals and camera, the aircraft can transmit imagery via the FPV camera, and the two cameras. Tap  to select the view.

With triple gimbals and cameras, the aircraft can transmit imagery via the FPV camera and the three cameras. Tap  to select the view.



- Refer to the H20T user manual for more details about related gimbals and camera features.
- Read the corresponding user manual for more camera view descriptions related to other types of gimbals and cameras.
- When using the 4G network function, the camera view will have a corresponding icon to display the network status.

Primary Flight Display (PFD)

Primary Flight Display (PFD) is a feature that can help users to fly more intuitively and easily, allowing users to see and avoid obstacles around the aircraft, as well as stop and adjust flight trajectory if necessary.



1. Speed wheel.
2. Horizontal speed.
3. Wind speed and direction. The wind direction is the direction of the aircraft relative to the absolute coordinate system, which is displayed as north to south from up to down, and west to east from left to right.
4. Artificial horizon: Reflect the attitude of the aircraft, which is opposite to the tilt angle of the aircraft.
5. Heading indicator: Always in the middle of the camera view.
6. Flight path vector: The position where the aircraft will fly to.
7. Displays the height limit.
8. Vertical obstacle indicator: Displays the vertical obstacle information. When there are obstacles above or below the aircraft, there is a white line shows the position that the aircraft can reach after 2s. It can be used to compare with the height of obstacles to avoid flight safety accidents.
9. Flight altitude: Shows the altitude of the aircraft relative to the takeoff point.
10. Displays the RTH height.
11. Vertical speed: Displays the vertical speed of the aircraft climbing or descending.
12. Absolute altitude: Displays the absolute altitude of the aircraft.
13. Home point.
14. Navigation display: Displays the aircraft and gimbal orientations, and obstacle avoidance information.

Aircraft and Gimbal Orientations

- a. Aircraft: When the aircraft rotates, the navigation display rotates.
- b. Aircraft horizontal speed vector: Displays the aircraft direction and speed.
- c. Aircraft orientation: Displays the current orientation of the aircraft. The displayed degree is counted clockwise from

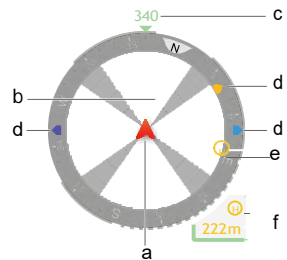

the north \square (the north is assumed to be 0 degree,) to the aircraft nose direction.

- d. The orientation of the three gimbals mounted on the aircraft: You can view the orientation of the gimbal relative to the aircraft in real time. When the gimbal rotates, the icon will rotate accordingly.
- e. Home point orientation: Displays the home position relative to the aircraft. When the home point distance exceeds 16 m, the home point resides on the edge of the navigation display.
- f. Home point distance: Displays the horizontal distance between the home point and the aircraft.

Obstacle Avoidance Display

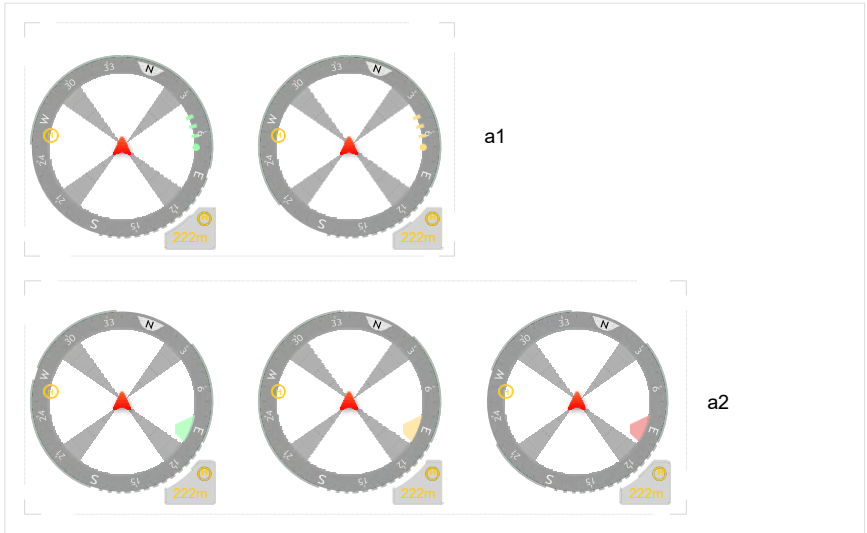

The light color areas are the obstacle avoidable areas of the aircraft, and the dark color areas are the blind spots. During flight, please avoid the aircraft speed vector line falling into the obstacle avoidance blind spot. In horizontal direction:

- a1. If the warning distance set in the app is greater than 16 m, once an obstacle is detected, it will display green in the direction of the obstacle; when the obstacle reaches the warning distance, it turns yellow; when the obstacle reaches near the obstacle breaking distance, it turns red.
- a2. If the warning distance set in the app is less than 16 m, the obstacle enters within 16 m will not reach the warning distance, the obstacle is indicated by a green frame; when the obstacle enters within 16 m and reaches the warning distance, it turns yellow; when the obstacle reaches near the obstacle breaking distance, it turns red.



- Once an obstacle is detected in the vertical direction, the vertical obstacle indicator bar appears. When the warning distance is reached, red and yellow bars are displayed; when the obstacle breaking is reached, a red bar is displayed.
- Follow the app instructions to set the warning distance and the obstacle breaking distance in app.
- When the obstacle reaches the warning distance, the remote controller will sound "B...B...B...", and sound "B.B.B." when the obstacle reaches near the obstacle breaking distance.

Laser Rangefinder (RNG)

1. Tap to enable the RNG.
2. The laser rangefinder is currently aiming at the target, and the distance between the target and the aircraft, the latitude, longitude, and altitude of the target are measured.
3. The linear distance between the target and the aircraft.
4. The horizontal distance between the target and the aircraft.

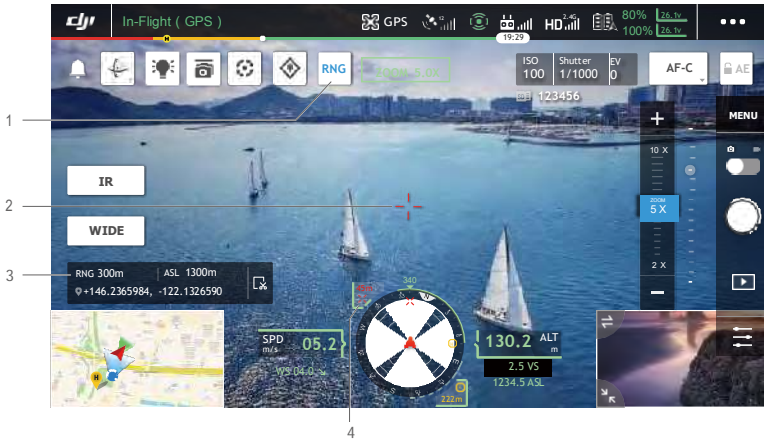

Smart Pin & Track

Smart Pin & Track includes Smart Track and PinPoint. The target point position identified by the Smart Pin & Track and RNG can be synchronized with other video transmission of H20 series cameras, FPV video transmission of aircraft, navigation display, and map page, etc. for display.

- ⚠ Please use Smart Track in an open environment to avoid frequent obstruction.
- The positioning effect of the PinPoint and RNG is limited by the aircraft GNSS positioning accuracy, the gimbal attitude accuracy, and other factors. The GNSS position, horizontal distance, navigation display, AR projection, etc. provided are for reference only.

Smart Track

Introduction

When using the H20 series, the Smart Track function can be used to identify, lock and track targets such as people, cars, boats, or other objects. After recognizing and locking the target, it will automatically control the gimbal to rotate, so that the target can be located in the center of the screen, and adjust the camera focal length to an appropriate focus rate to track and view the target.

- ⚠ When the tracking target is set to objects, the tracking effect is limited.

- ⚠ When the aircraft is going home, landing or the flight mode switch is in the T position, the Smart Track is disabled. Once the above situation occurs during the operation of Smart Track, it will immediately exit the function.

Identifying and locking the object

After entering the zoom view (supporting the payload) in the app, Smart Track can be enabled.

1. Click to start or stop Smart Track.
2. Identify people, cars, and ships as candidate targets. You can also make gestures on the screen to select other objects as targets.
3. Click to switch target tracking to gimbal follow mode or gimbal free mode.

- ⚠️ • When the user selecting other types of targets through gesturing on the screen, once a person, car or boat appears in the frame area, the person, car or boat will be selected as the target to start tracking.
- When selection through gestures, if the characteristics of the target are not clear, it will cause the selection to fail.

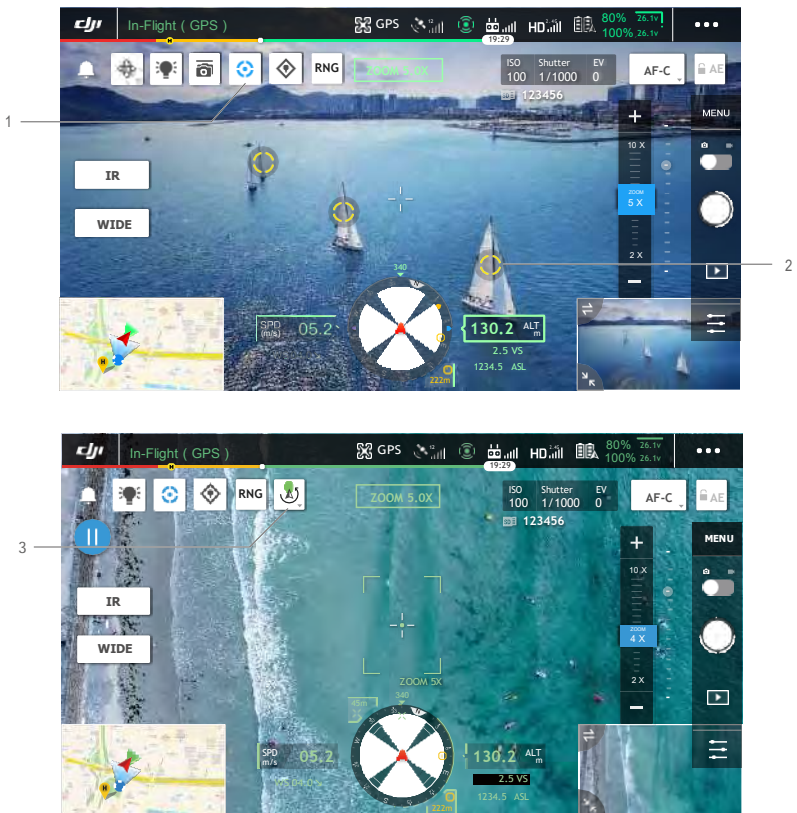

Tracking target (in gimbal follow mode)

In gimbal follow mode, the orientation of the aircraft heading is always consistent with the gimbal, both aiming at the target. At this time, the attitude of the gimbal will be automatically adjusted so that the target can be in the center of the screen, and the user can fine-tune the field of view by trimming the gimbal dial; the camera will automatically adjust the zoom to make the size of the target suitable. The Zoom Menu and the right dial on the remote control can also be used to adjust the size of the target.

Target prediction: When a target is lost from the view in the app, it will predict the position of the target and display it on the screen based on the historical motion trajectory.

Target search: When the target is lost from the view in the app, it will automatically search for the target based on the predicted position of the target. You can also manually control the the gimbal rotation and the camera zoom to find the target.

Target positioning: The GNSS position of the target will be displayed in the navigation display and map (note that when the laser rangefinder of the H20 series gimbal and camera continues to be invalid, the target position is for reference only), the position of the target will also be displayed in the FPV view.

Focus tracking: The camera focus will be actively enhanced according to the distance of the target object.

In gimbal follow mode, the top flight status bar will display ST after entering tracking. The control mode of the aircraft is slightly different from the normal flight mode. Please make sure you are familiar with the following controls and fly carefully.

| Remote controller operation | Aircraft performed | Important |
|------------------------------------|--|--|
| Press and hold on the Pause button | Exit the target tracking and return to the target selection stage. | ---- |
| Yaw stick | Adjust gimbal yaw. | The adjustable range is limited during tracking. |
| Pitch stick | Fly the aircraft to or away from the target horizontally. The maximum flight speed is less than 17 m/s. By continuously controlling the stick, the aircraft will continue to track the target. | When the horizontal distance between the aircraft and the target is small, the speed in the direction close to the target will be limited. The aircraft cannot approach the target in the following conditions: a. The aircraft is less than 5 meters from the target b. The target is under the aircraft (the pitch of the gimbal is greater than 80 °) |
| Roll stick | Fly the aircraft to rotate the target horizontally. The maximum flight speed is less than 17 m/s. | When the horizontal distance between the aircraft and the target is small, the orbit speed will be limited. |
| Throttle stick | Control the aircraft height. | ---- |
| Gimbal pitch control dial | Adjust the gimbal pitch. | The adjustable range is limited during tracking. |
| Gimbal pan control dial | Adjust the camera zoom. | The adjustable range is limited during tracking. |
| Flight mode switch to T position | Exit Smart Track. | Can be used for emergency exit. |
| Flight mode switch to S position | Switch to gimbal free mode. | Will not switch to the gimbal follow mode once switched to P mode. |



- When entering Smart Track, the camera will automatically switch to AF-C focus mode.
- In order to ensure the shooting effect of dynamic target, taking photos during the target tracking will not lock the gimbal. At this time, the static background may produce motion blur.



- Bellow scenes may have poor recognition or tracking effects:
- When used at night, the recognition may become worse.
 - When the load is working at high magnification, the tracking effect may become worse.
 - In an environment with poor visibility such as rain, fog and haze, the tracking effect may become worse.
 - In scenes with heavy traffic and crowds of similar objects, the tracked object/target may change.

Tracking target (in gimbal free mode)

When the current state of the aircraft does not meet the operating conditions of the gimbal follow mode, it will automatically switch to the gimbal free mode. The possible switching situations are:

- When the aircraft flight control and the gimbal control belong to two different remote controllers.
- Flight mode switch is at S position.
- The aircraft is in attitude mode.
- Manually switch to gimbal free mode by tapping .
- The aircraft does not take off.

In gimbal free mode, the top flight status bar will not change after entering tracking. The control mode of the aircraft is the same as the normal flight mode.

| Remote controller operation | Aircraft performed | Important |
|------------------------------------|--|--|
| Press and hold on the Pause button | Exit the target tracking and return to the target selection stage. | ---- |
| Yaw stick | The same as the normal flight mode. | The aircraft and gimbal heading are different, please fly carefully. |
| Pitch stick | | |
| Roll stick | | |
| Throttle stick | | |
| Gimbal pitch control dial | Adjust the gimbal pitch. | The adjustable range is limited during tracking. |
| Gimbal pan control dial | Adjust the camera zoom. | The adjustable range is limited during tracking. |
| Flight mode switch to T position | Exit the Smart Track. | Can be used for emergency exit. |



- In gimbal free mode, the landing gear of the aircraft may appear in the view.
- In gimbal free mode, the gimbal rotation range is limited by the gimbal mechanical limit.

PinPoint

PinPoint can only be used with the H20 series gimbal and camera. PinPoint can identify the location of the target, which is convenient for information synchronization.

1. Adjust the attitude of the aircraft and the gimbal to move the target to the center of the view. Tap on the target in the center of the view to record the point location.
2. Record the latitude, longitude and altitude of the point. Currently only one point is supported. When the next point is recorded, the previous point information will be overwritten.

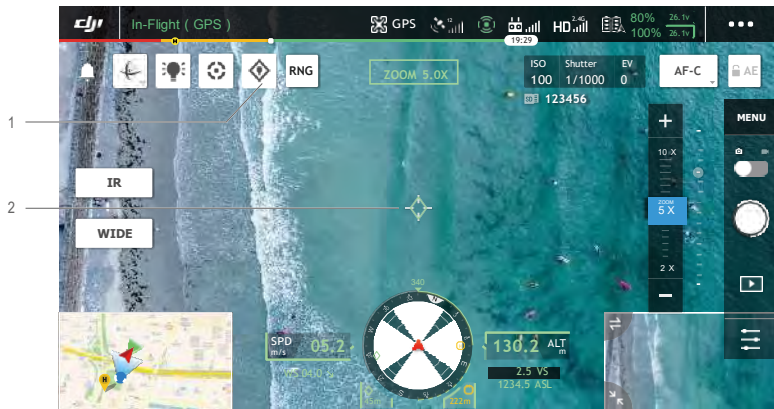

1. Tap to record a point in the center of the map. The altitude of this point is the current aircraft altitude.
2. Tap to view the coordinates of the point, and the height of the point can be edited and deleted; press and drag to change its latitude and longitude.

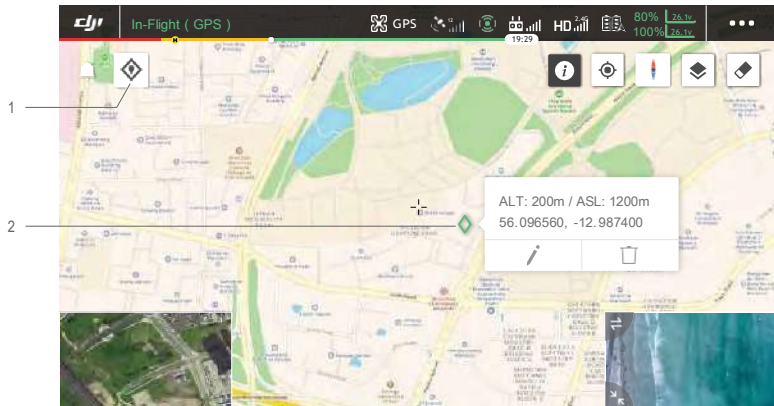

Location Sharing

The target point position identified by Smart Track, PinPoint and RNG can be synchronized to other video transmission of H20 series cameras, FPV video transmission of aircraft, navigation display, map page, and DJI FlightHub*, etc. for display.

*Coming soon.

A. Other video transmission of H20 series cameras

1. When Smart Track is enabled, the target point is marked in green in the center.
2. When PinPoint is enabled, the target point is displayed on the screen.
3. When RNG is enabled, the target point is marked in red in the center.

⚠ If Smart Track and RNG are enabled at the same time, and the target point is in the center of the view, only the green mark of Smart Track will be displayed.

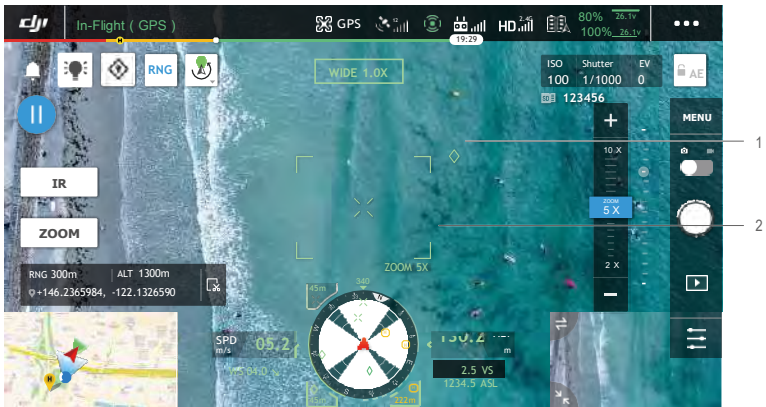

B. FPV / Navigation display

1. On the FPV, you can see the location of the target points of Smart Track, PinPoint, and RNG.

2. The navigation display shows the orientation and distance of the target point relative to the aircraft. If the distance is too far (the target point is not in the camera view), the icon of the target point will reside on the edge of the navigation display.
3. View the horizontal distance between the aircraft and the target of Smart Track or RNG.
4. View the horizontal distance between the aircraft and the target of PinPoint.

⚠ If Smart Track and RNG are enabled at the same time, and the target point is in the center of the view, only the green mark of Smart Track will be displayed.



C. Map

You can see the location of the target points of Smart Track, PinPoint, and RNG. Tap to view the target coordinate.

⚠ If Smart Track and RNG are enabled at the same time, and the target point is in the center of the view, only the green mark in Smart Track will be displayed.

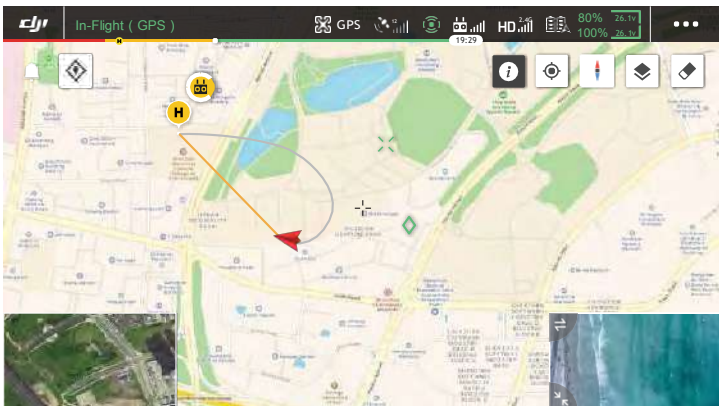

Mission Flight

Introduction

Tap to enter the mission library. Users can view the created flight routes, or newly created Waypoint flight, Mapping or Oblique Photography missions. Among them, the Mapping or Oblique Photography missions are generated by App, and the Waypoint flight can be created through Set Waypoints or Live Mission Recording.



Use Set Waypoints to create a route by adding editable waypoints on the map. Use Live Mission Recording to create a route by adding waypoints and edit the target in the photo along the route. Moreover, users can also edit the mission during flights, when in flight editing mode.

There are two functions which can be achieved:

Waypoints 2.0: Edit and save the waypoints before takeoff then start flying.

AI Spot-check: Edit and save the waypoints during flight, the mission will be saved after flight.

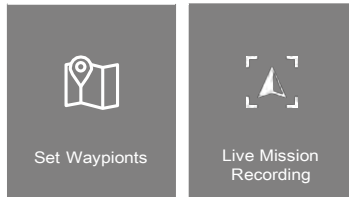

Set Waypoint

Tap Create a Route, Waypoint flight, and then Set Waypoints to create a new flight route and edit waypoints.

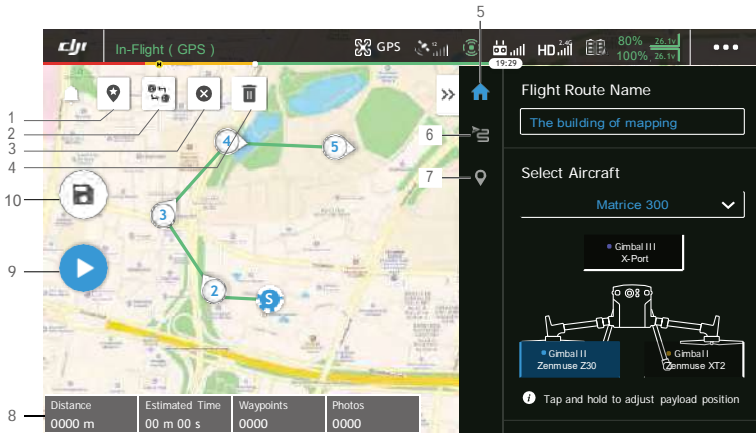

Tap on the map to add waypoints, then configure route and waypoints settings.

1. Point of Interest (POI)

 : Tap to enable the POI function and a POI will be displayed on the map. Drag to adjust its position. When the POI function is enabled, the drone yaw can be set to center to POI so that the aircraft nose points at the POI during the mission. Tap this icon again to disable the POI function.

2. Reverse Path

 : Tap to swap the start and end points to reverse the flight path. "S" refers to the start point.

3. Clear Waypoints

 : Tap to clear all the added waypoints.

4. Delete Selected Waypoint

 : Tap to delete the selected waypoint.

5. Parameters List

Edit the route name, set the aircraft type as M300 RTK, and configure the gimbal and camera.

6. Route Settings

The settings are applied to the entire route, including aircraft speed, height, aircraft yaw, gimbal control, waypoint type, power saving mode and completion action.

7. Waypoint Settings

Select a waypoint and then set waypoint parameters. Tap "<" or ">" to switch to the previous or next waypoint. The settings are applied to the selected waypoint, including aircraft speed, height, aircraft yaw, waypoint type, waypoint actions, longitude and latitude.

8. Mission Information

Shows the flight length, estimated flight time, waypoint quantity, photo quantity, longitude and latitude.

9. Perform

 : Tap the button and then check the settings and status of the aircraft in the pop-up checklist. Tap the "Start to Fly" button to perform the mission.

10. Save

 : Tap to save current settings.

Live Mission Recording

Tap Create a Route, Waypoint flight, and then Live Mission Recording to record actions such as photo capture.

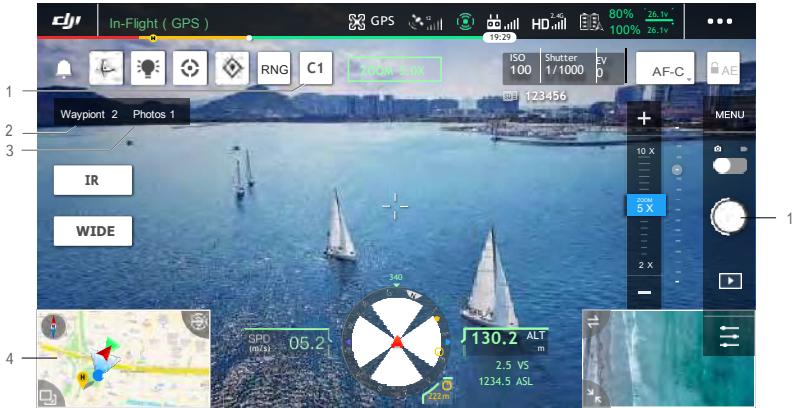

1. Tap C1 to pin a point or capture a photo, the waypoint number and the photo number will increase.
2. Waypoint number.
3. Photo number.
4. Tap to enter the map page for editing. Tap to save current settings, and a flight route is created. When used with the H20 series gimbal and camera, tap Next to enter the AI Spot-check page for editing.

AI Spot-check

When pairing the M300 RTK with the H20 series payload, AI Spot-check is available. In AI Spot-check page, you can switch from different photos, drag-select photos and adjust the size. When the route is executed, the selected object will be accurately photographed.

- a. Back.
- b. Displays the waypoint number and the photo number.
- c. Displays the gimbal and lens of the photo.
- d. Photo thumbnails, tap to select the photo that needs to be edited accurately. The photo has been edited by AI Spot-check, and is marked with .
- e. Gesture to select the object in the photo, adjust the selection box size, drag or delete the selection box, and the selection box will follow the picture so as to enlarge or reduce. Tap once on the picture to hide / show other buttons and tools on the screen.
- f. Tap to save the flight route settings and the AI Spot-check configurations, and a flight route is created.

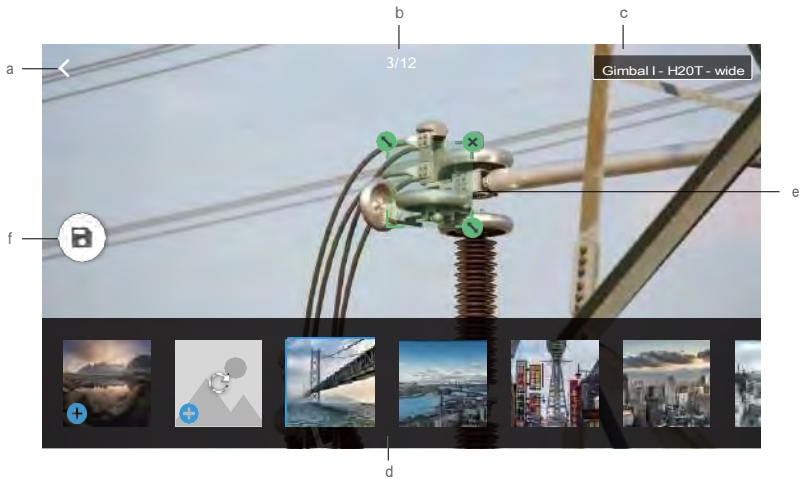

- ⚠ AI Spot-check can only be used with the H20 series payload in zoom camera view.
- AI Spot-check takes photos at up to 10 times the focal length.
- RTK should be used for photo capture and Planned Route flight of the AI Spot-check, and the RTK base station coordinates of the photo capture and Planned Route flight must be the same.
- AI Spot-check can support up to 750 photos.
- The ratio of the selection box size of the photo to the area of the whole photo cannot be less than 1/25 when using AI Spot-check.
- The selection box position must be in the middle of the view and the size needs to be the same as the target size.
- If Advanced Dual Operator Mode is in use, Controller A must be used to complete the Demo Flight and mission upload.
- H20 and H20T gimbal and camera should be installed on the 1st gimbal port.

In-Flight Editing

Enter the mission library, select a created flight route, tap to start the mission, or tap to edit the flight route.

1. Tap to enter In-Flight Editing page. The editions will be merged into the original route after saved.
2. Tap to enter Set Waypoints page.
3. Tap to enter AI Spot-check page.
4. Flight limit information
 - : Tap to see the flight limit information.
5. Location
 - : Tap to center the map around the aircraft's location.
6. Map Lock
 - : Map rotation is locked by default. North is at the top. Tap the button to unlock rotation. Users can adjust the map orientation by tapping and rotating two fingers on the map.

7. Map Mode

 : Tap to switch between Standard and Satellite mode.

8. Clear Screen

 : Tap to clear the flight path currently shown on the map.

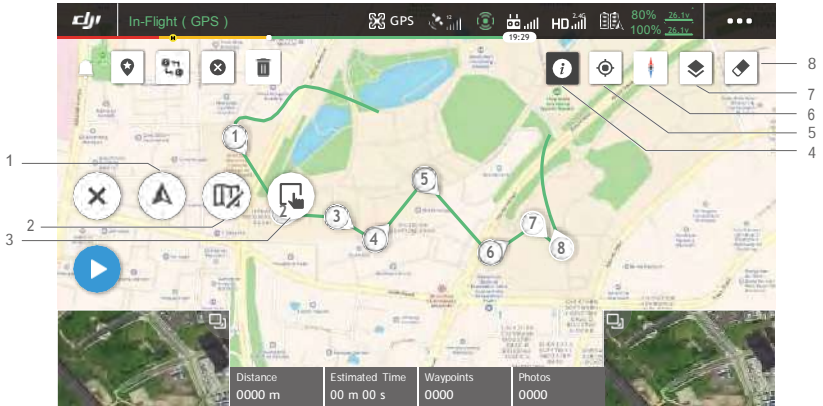

UAV Health Management System (HMS)

HMS can provide error displays, error records, manage logs and maintenance instructions.

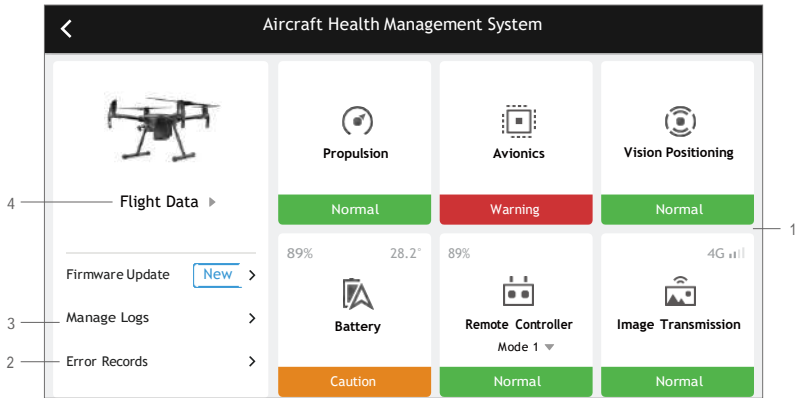

1. Error displays

Check the current health status of each module of the aircraft, and the user can solve the corresponding abnormality according to the prompt.

| Color | Status | Color | Status |
|--------|--------|--------|---------|
| Green | Normal | Orange | Caution |
| Yellow | Notice | Red | Warning |

2. Error records

Records of historical data of the aircraft are used to confirm whether there are any serious problems during the use of the aircraft. This makes it convenient for the user to evaluate the stability of the aircraft and assist after-sales when conducting an analysis.

3. Manage logs

Maintain recent aircraft logs. This data can be used to identify aircraft abnormalities and enhance aircraft management. Users can directly send the logs to the DJI after-sales team through the App.

4. Maintenance instructions

Users can view historical flight data and the maintenance manual, then be able to determine whether maintenance is required.

Album

View your masterpieces all in one place. You can save the photos or videos to your mobile device.

DJI FlightHub

Content related to DJI FlightHub will be shown here if the DJI account used has a FlightHub license. DJI FlightHub is a web-based drone management platform that provides users with real-time monitoring, flight logs and data, team management and more.

For more information, please visit www.dji.com/flighthub

Menu

Tap  on the upper right corner to enter the menu for offline maps, flight records, GEO unlocking, privacy settings and more.

Flight

This section describes safe flight practices and flight restrictions.

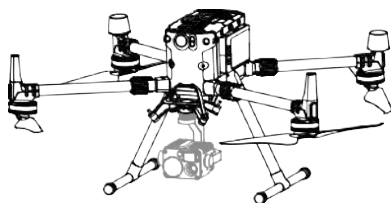

Flight

Once pre-flight preparation is complete, it is recommended to use the flight simulator in DJI Assistant 2 for Matrice to hone your flying skills and practice flying safely. Ensure that all flights are carried out in an open area. It is important to understand basic flight guidelines for the safety of both you and those around you. Refer to the Disclaimer and Safety Guidelines for more information.

Flight Environment Requirements

1. DO NOT use the aircraft in severe weather conditions such as where wind speeds exceed 15 m/s. When flying in rain, refer to the flight requirements listed in the IP45 Protection Rating section on Page 38.
2. When flying in open areas, tall and large metal structures may affect the accuracy of the onboard compass and GNSS system. Make sure to operate the aircraft by following the prompts in the app.
3. Avoid obstacles, crowds, high voltage power lines, trees, and bodies of water.
4. Minimize interference by avoiding areas with elevated levels of electromagnetism, including base stations and radio transmission towers.
5. Aircraft and battery performance are subject to environmental factors such as air density and temperature. Be very careful when flying at high altitudes, as battery and aircraft performance may be affected.
6. The compass and GNSS will not work in Polar Regions. Fly carefully.

GEO (Geospatial Environment Online) System

Introduction

DJI's Geospatial Environment Online (GEO) System is a global information system committed to providing real-time airspace information within the scope of international laws and regulations. GEO provides flight information, flight times and location information to assist Unmanned Aerial Vehicle (UAV) users in making the best decisions related to their personal UAV use. It also includes a unique Regional Flight Restrictions feature which provides real-time flight safety and restriction updates and blocks UAVs from flying in restricted airspace. While safety and obeying air traffic control laws is a paramount concern, DJI recognizes the need for exceptions to be made under special circumstances. To meet this need, GEO also includes an Unlocking feature that enables users to unlock flights within restricted areas. Prior to making their flight, users must submit an unlock request based on the current level of restrictions in their area.

GEO Zones

DJI's GEO System designates safe flight locations, provides risk levels and safety concerns for individual flights, and offers restricted airspace information, which can be viewed by users in real time on the DJI Pilot app. The locations designated by GEO are called GEO Zones. GEO Zones are specific flight areas that are categorized by flight regulations and restrictions. GEO Zones that prohibit flight are implemented around locations such as airports, power plants, and prisons. They can also be temporarily implemented around major stadium events, forest fires, or other emergency situations. Certain GEO Zones do not prohibit flight but do trigger warnings informing users of potential risks. All restricted flight areas are referred to as GEO Zones, and are further divided into Warning Zones, Enhanced Warning Zones, Authorization Zones, Altitude Zones, and Restricted Zones. By default, GEO limits flights into or taking off within zones that may result in safety or security concerns. There is a GEO Zone Map, which

contains comprehensive global GEO Zone information on the official DJI website: <https://www.dji.com/flysafe/geo-map>.

The GEO System is for advisory purposes only. Individual users are responsible for checking official sources and determining which laws or regulations may apply to their flight. In some instances, DJI has selected widely-recommended general parameters (such as a 1.5-mile radius at airports) without making any determination as to whether these guidelines match regulations that apply to specific users.

GEO Zone Definitions

Warning Zones: Users receive a warning message with information relevant to their flight.

Enhanced Warning Zones: Users receive a prompt from the GEO System at the time of flight. They are required to submit an unlock request to fly in the zone, for which they must confirm their flight path.

Authorization Zones: Users receive a warning message and the flight is prohibited by default. Authorization Zones can be unlocked by authorized users with a DJI-verified account. Self-Unlocking privileges must be applied for online.

Altitude Zones: Flights are limited to a specific altitude.

Restricted Zones: Flights are completely prohibited. UAVs cannot fly in these zones. If you have obtained permission to fly in a Restricted Zone, please go to <https://www.dji.com/flysafe> or contact flysafe@dji.com to unlock the zone.

DJI GEO Zones aim to ensure the user's flight safety, but it cannot be guaranteed to be in full compliance with local laws and regulations. Users should check local laws, regulations, and regulatory requirements before each flight and are responsible for the flight safety.

All intelligent flight features will be affected when DJI aircraft fly nearby or into GEO Zones. Such interference includes, but is not limited to, decreased speed, takeoff failure, and flight termination.

Flight Restrictions

Introduction

UAV operators should abide by all flight regulations established by the relevant government and regulatory agencies, including the ICAO and the FAA. For safety reasons, flights are restricted by default, which helps users operate DJI products safely and legally. Flight restrictions include altitude and distance limits, and GEO Zones.

When Global Navigation System Service (GNSS) is available, altitude limits, distance limits, and GEO Zones are all taken into account to ensure flight safety. Otherwise, only altitude limits take effect.

Maximum Altitude & Radius Restrictions

Maximum flight altitude restricts an aircraft's flight altitude, while maximum radius restricts its distance. These limits can be set using the DJI Pilot app.

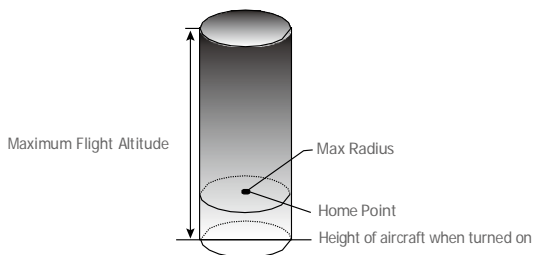

| Strong GNSS Signal | | |
|--------------------|--|--|
| Restriction | Description | DJI Pilot App Message |
| Max Altitude | Aircraft's altitude cannot exceed the specified value. | Maximum Flight Altitude reached. Adjust your altitude using FC Settings if required. |
| Max Radius | Flight distance cannot exceed the specified value. | Maximum Flight Distance reached. Adjust your distance using FC Settings if required. |

| Weak GNSS Signal | | |
|------------------|--|--|
| Restriction | Description | DJI Pilot App Message |
| Max Altitude | Altitude is restricted to 26 ft. (8 m) when GNSS signal is weak and the Vision System is activated. Altitude is restricted to 98 ft. (30 m) when GNSS signal is weak and the Vision System is deactivated. | Maximum Flight Altitude reached. Adjust your altitude using MC Settings if required. |
| Max Radius | No limit. | N/A |

- ⚠
- When an aircraft exceeds a specified limit, the pilot can still control the aircraft but it will be unable to fly any farther.
 - For safety reasons, DO NOT fly near airports, highways, railway stations, railway lines, city centers, or other sensitive areas. Only fly aircraft in areas that are within your direct line of sight.

GEO Zone Flight Restrictions

| GEO Zone | Description |
|-----------------------|---|
| Restricted Zone | Takeoff: The aircraft's motors cannot be started. |
| | In-flight: When GNSS signal changes from weak to strong, DJI Pilot starts a countdown. Once the countdown is over, the aircraft immediately lands in semi-automatic descent mode and turns off its motors after landing. |
| | In-flight: When the aircraft approaches the boundary of the Restricted Zone, it automatically decelerates and hovers. |
| Authorization Zone | Takeoff: The aircraft's motors cannot be started. Takeoff is only available after submitting an unlock request with the user's phone number. |
| | In-flight: When GNSS signal changes from weak to strong, DJI Pilot starts a countdown. Once the countdown is over, the aircraft immediately lands in semi-automatic descent mode and turns off its motors after landing. |
| Enhanced Warning Zone | The aircraft flies normally but the user is required to confirm the flight path. |
| Warning Zone | The aircraft flies normally but the user receives warning messages. |
| Altitude Zone | When GNSS signal is strong, the aircraft cannot exceed the specified altitude. In-flight: When GNSS signal changes from weak to strong, if the aircraft is higher than the height limit, the aircraft will descend and hover below the altitude limit. |
| | When the GNSS signal is strong, the aircraft approaches the boundary of the Altitude Zone. If it is higher than the altitude limit, the aircraft decelerates and hovers in place. |
| | When the GNSS signal changes from weak to strong, if the aircraft is higher than the height limit, DJI Pilot app starts a countdown. Once the countdown is over, the aircraft will descend and hover below the altitude limit. |
| Free Zone | The aircraft flies normally with no restrictions. |



Semi-Automatic Descent: All stick commands are available except the throttle command and RTH button during descent and landing. The aircraft's motors turn off automatically after landing. It is recommended to fly the aircraft to a safe location to land immediately.

GEO Unlocking

Due to differing laws and regulations between countries and regions, and differing flight restrictions between GEO Zones, DJI provides users with two methods for unlocking GEO Zones: Self-Unlocking and Custom Unlocking.

Self-Unlocking is used for Authorization Zones, where the user is required to submit an unlock request by authenticating their phone number for a registered DJI account. This feature is only available in certain countries. Users can choose whether to submit their unlock request via the website at <https://www.dji.com/flysafe> (Scheduled Self-Unlocking), or through the DJI Pilot app (Live Self-Unlocking).

Custom Unlocking is based on special requirements for individual users. It sets a special flight area that users can unlock by providing flight permission files according to their specific GEO Zone and other requirements. It is available in all countries and can be applied for on the website: <https://www.dji.com/flysafe>.

For more information about unlocking, please visit <https://www.dji.com/flysafe> or contact flysafe@dji.com.

Preflight Checklist

1. Remote controller, Intelligent Flight Battery, and display device are fully charged.
2. Frame arms are unfolded and locked firmly, landing gears are mounted firmly, and batteries are locked firmly.
3. All the devices' firmware is up-to-date.
4. microSD card has been inserted, if necessary.
5. Gimbal is functioning normally.
6. Motors can start and are functioning normally.
7. The DJI Pilot app is successfully connected to the aircraft.
8. Ensure that the sensors for the Vision and Infrared Sensing Systems are clean.
9. DO NOT face the battery connector downwards to the ground to avoid getting dust or water into the battery connector.
10. Make sure that the gimbal dampener is without obvious wear and tear, and the gimbal anti-drop rope has been fastened.

Calibrating the Compass

Only calibrate the compass when the DJI Pilot app or the status indicator prompts you to do so. Observe the following rules when calibrating your compass:



- DO NOT calibrate your compass where there is a chance of strong magnetic interference, such as near magnets, parking structures, or steel reinforcements underground.
- DO NOT carry ferromagnetic materials with you during calibration such as cellular phones.
- The DJI Pilot app will notify you if the compass is affected by strong interference after calibration is complete. Follow the prompts to resolve the compass issue.

Calibration Procedures

Choose an open area to carry out the following procedures.

1. Tap the Aircraft Status Bar in the app and select Calibrate, then follow the on-screen instructions.
2. Hold the aircraft horizontally and rotate it 360 degrees. The Aircraft Status Indicators will go solid green.

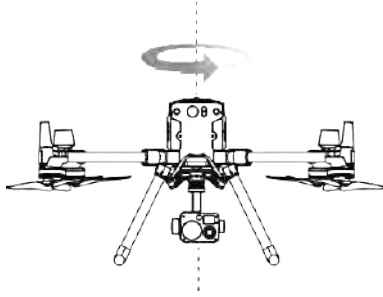

3. Hold the aircraft vertically, with the nose pointing downward, and rotate it 360 degrees around the center axis. Re-calibrate the aircraft if the aircraft status indicators blink red.

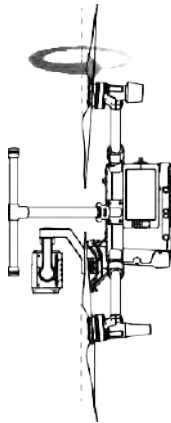

If the Aircraft Status Indicator blinks red and yellow after the calibration procedure, move your aircraft to a different location and try again.



- DO NOT calibrate the compass near metal objects such as a metal bridge, cars, scaffolding.
- If the aircraft status indicators are blinking red and yellow alternately after placing the aircraft on the ground, the compass has detected magnetic interference. Please change your location.

Starting/Stopping the Motors

Starting Motors

The Combination Stick Command (CSC) is used to start the motors. Push both sticks to the bottom inner or outer corners to start the motors. Once the motors start spinning, release both sticks simultaneously.



Stopping the Motors

There are two ways to stop the motors:

1. When the aircraft has landed, push and hold the left stick down. The motors will stop after three seconds. (Recommended).
2. When aircraft has landed, push the left stick down ①, then conduct the same CSC that was used to start the motors, as shown above ②. Motors will stop immediately. Release both sticks once motors stop.

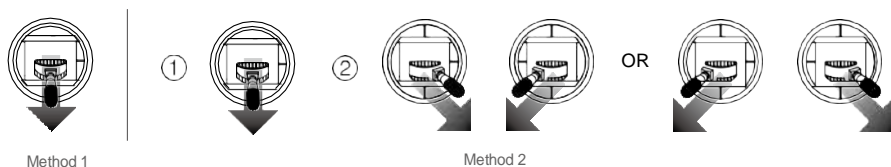

Emergency Propeller Stop

The Combination Stick Command (CSC) can be used to execute the emergency propeller stop once the flight controller detects critical error during flight.



Flight Test

Takeoff/Landing Procedures

1. Place the aircraft in an open, flat area with the battery level indicators facing towards you.
2. Turn on the remote controller, then turn on the aircraft.
3. Launch DJI Pilot and enter the Camera View.
4. Wait until the Aircraft Status Indicators blink green (with single point positioning) or blink green and blue alternately (RTK).
5. If the Intelligent Flight Battery temperature is low, use the self-heating function to heat the batteries to ensure the temperature is suitable for the aircraft to take off.
6. Turn on the motors using CSC and push the left stick up slowly to take off.
7. To land, hover over a level surface and gently pull down on the left stick to descend.

8. After landing, execute the CSC command or hold the left stick at its lowest position until the motors stop.
9. Turn off the Intelligent Flight Battery first, then the remote controller.



- When the Aircraft Status Indicators blink yellow rapidly during flight, the aircraft has entered Failsafe mode.
- A low battery level warning is indicated by the Aircraft Status Indicators blinking red slowly or rapidly during flight.
- Watch our video tutorials for more flight information.

Three-propeller Emergency Landing

During flight, if the aircraft lacks one lift output (e.g. propulsion system failure of a motor), it will automatically switch to the Three-propeller Emergency Landing Mode. The flight controller will try to maintain the stability and controllability of attitude and velocity, and make the aircraft automatically descent in this mode. This mode enables a user to land the aircraft onto a safe zone by controlling the aircraft, helps to reduce the chance for the aircraft and payload to drop, and damage the people and property on the ground.

When the aircraft enters the Three-propeller Emergency Landing Mode, the remote controller will alert the user by vibrating. At this time, the aircraft will enter rapid spin and automatically descend by default. The stick that controls back and forth movement will be adjusted to control the north-south movement and the stick that controls the left and right movement will be adjusted to control the west-east movement. The user can operate the sticks to move the aircraft to the appropriate landing area as soon as possible. When the aircraft reaches near to the ground, user can use the Emergency propeller stop to land the aircraft to minimize the drop loss caused by the aircraft spin.



- Three-propeller Emergency Landing requires that the takeoff weight of the aircraft to be less than 7.7 kg and it should work in open space with the flight height that exceeds 10 m.
- Once such a failure occurs, please move the aircraft immediately away from people and valuables, and land on a level and soft surface (e.g. grass) to reduce damaging the aircraft.
- If a propeller is damaged but the motor is still working normally, the aircraft will not enter the Three-propeller Emergency Landing Mode.
- Three-propeller Emergency Landing is only used as an emergency protection function when the propulsion system fails. Please do not actively trigger it.
- Make sure that all firmware is up-to-date.
- After landing, contact DJI support for the propulsion system maintenance as soon as possible.

Appendix

Appendix

Specifications

| Aircraft | |
|---|--|
| Dimensions (Unfolded, propellers excluded) | 810×670×430 mm (L×W×H) |
| Dimensions (Folded) | 430×420×430 mm (L×W×H) |
| Diagonal Wheelbase | 895 mm |
| Weight (Batteries excluded) | 3600 g |
| Max Payload | 2700 g |
| Max Takeoff Weight | 9000 g |
| Operating Frequency | 2.400 - 2.4835 GHz; 5.725 - 5.850 GHz |
| Transmitter Power (EIRP) | 2.400 - 2.4835 GHz: 29.5 dBm (FCC); 18.5 dBm (CE); 18.5 dBm (SRRC); 18.5 dBm (MIC) 5.725 - 5.850 GHz: 28.5 dBm (FCC); 12.5 dBm (CE); 28.5 dBm (SRRC) |
| Hovering Accuracy (Windless or breezy) | Vertical: ±0.1 m (Vision System enabled) ±0.5 m (P-mode with GPS) ±0.1 m (D-RTK) Horizontal: ±0.3 m (Vision System enabled) ±1.5 m (P-mode with GPS) ±0.1 m (D-RTK) |
| Max Angular Velocity | Pitch: 300°/s, Yaw: 100°/s |
| Max Pitch Angle | 30° (P-mode and Forward Vision System enabled: 25°) |
| Max Ascent Speed | 6 m/s |
| Max Descent Speed (vertical) | 5 m/s |
| Max Descent Speed (tilt) | 7 m/s |
| Max Horizontal Speed | 23 m/s |
| Max Service Ceiling Above Sea Level | 5000 m (with 2110 Propellers, and takeoff weight ≤7 kg) / 7000 m (with 2195 High Altitude Low Noise Propellers, and takeoff weight ≤7 kg) |
| Max Wind Resistance | 15 m/s |
| Max Forward Flight Time (Sea level) | 45 minutes (Load weight 700 g) |
| Max Hover Time (Sea level) | 43 minutes (Load weight 700 g) |
| Motor Model | 6009 |
| Propeller Model | 2110 |
| Supported DJI Gimbals | Zenmuse XT2 / XT S / Z30 / H20 / H20T |
| Supported Gimbal Configurations | Dual Downward Gimbals, Single Upward Gimbal, Single Downward Gimbal, Single Downward Gimbal+Single Upward Gimbal, Dual Downward Gimbals+Single Upward Gimbal |

| | |
|--|--|
| Other Supported DJI Products | CSM Radar, Manifold 2 |
| Ingress Protection Rating | IP45 |
| GNSS | GPS+GLONASS+BeiDou+Galileo |
| Operating Temperature | -20° to 50°C (-4° to 122° F) |
| Smart Controller | |
| OcuSync Enterprise Operation Frequency Range | 2.400 - 2.4835 GHz; 5.725 - 5.850 GHz* |
| Max Transmission Distance (Unobstructed, free of interference) | NCC / FCC: 15 km CE / MIC: 8 km SRRC: 8 km |
| Transmitter Power (EIRP) | 2.400 - 2.4835 GHz: 29.5 dBm (FCC); 18.5 dBm (CE) ; 18.5 dBm (SRRC); 18.5 dBm (MIC) 5.725 - 5.850 GHz: 28.5 dBm (FCC); 12.5 dBm (CE); 20.5 dBm (SRRC) |
| External Battery | Name: WB37 Intelligent Battery Capacity: 4920 mAh; Voltage: 7.6 V Battery Type: LiPo; Energy: 37.39 Wh Charge Time (Using BS60 Intelligent Battery Station): 70 min (15° to 45° C); 130 min (0° to 15° C) |
| Built-in Battery | Battery Type: 18650 Li-ion (5000 mAh @ 7.2 V) Charge Type : Supports USB charger rated 12 V / 2 A Rated Power: 17 W** Charge Time: 2 hours and 15 minutes (Using a USB charger rated 12 V / 2 V) |
| Working Time | Built-in Battery: Approx. 2.5 hours Built-in Battery + External Battery: Approx. 4.5 hours |
| Power Supply Voltage / Current (USB-A port) | 5 V / 1.5 A |
| Operation Temperature Range | -20° to 40° C (-4° to 104° F) |
| Storage Capacity | Rom: 32 GB + scalable with microSD |
| Vision System | |
| Obstacle Sensing Range | Forward / Backward / Left / Right: 0.7 - 40 m Upward / Downward: 0.6 - 30 m |
| FOV | Forward / Backward / Downward: 65°(H), 50°(V) Left / Right / Upward: 75°(H), 60°(V) |
| Operating Environment | Surfaces with clear patterns and adequate lighting (> 15 lux) |
| Infrared Sensing System | |
| Obstacle Sensing Range | 0.1 - 8 m |
| FOV | 30° |

Operating Environment Large, diffuse, and reflective obstacles (reflectivity >10%)

Intelligent Flight Battery

Capacity 5935 mAh

Voltage 52.8 V

Battery Type LiPo 12S

Energy 274 Wh

Net Weight (Single One) Approx. 1.35 kg

Operating Temperature -4° to 122°F (-20° to 50°C)

Storage Temperature 71.6° to 86°F (22° to 30°C)

Charging Temperature 41° to 104°F (5° to 40°C)

Max Charging Power 470 W

Auxiliary Light

Effective Illumination Distance 5 m

Illumination Mode 60 Hz, solid on

FPV Camera

Resolution 960p

FOV 145°

Frame rate 30fps

* Local regulations in some countries prohibit the use of the 5.8 GHz and 5.2 GHz frequencies and in some regions the 5.2 GHz frequency band is only allowed for indoor use.

** The Smart Controller will supply power for the mobile device installed, which may affect the above-mentioned specifications.

Firmware Update

Use the DJI Pilot app or the DJI Assistant 2 for Matrice to update the remote controller, aircraft and other connected DJI devices.

For the Zenmuse Z30, XT S and XT2, only aircraft firmware can be updated via DJI Assistant 2 for Matrice or the DJI Pilot app. Gimbal firmware must be updated via a microSD card.

Using DJI Pilot

1. Ensure that there is good connection between the aircraft and remote controller and other DJI devices used with the aircraft, and that all the devices are powered on.
2. Go to the app. A prompt will appear if new firmware is available for download. Follow the on-screen instructions to update the firmware. Make sure to connect to the Internet when downloading the firmware.

 For the Zenmuse H20, H20T, and DJI ENTERPRISE X-Port, updates are supported via the app. The aircraft and gimbal firmware will be updated simultaneously.

Using DJI Assistant 2 for Matrice

For the remote controller, M300 RTK aircraft, H20 series and X-Port payload*, users can connect each device to the software and then run a firmware update to update firmware on the devices accordingly.

Remote Controller Firmware Update

1. Power on the remote controller and aircraft. Connect the remote controller to a PC with a USB cable with dual A-port.
2. Tap  to set as USB data export mode in the remote controller's Quick Settings.
3. Click the corresponding device name and then the firmware update tag.
4. Select the firmware version required. Make sure to connect to the Internet when downloading the firmware.
5. Restart the device after the firmware update is complete.

Aircraft Firmware Update

1. Power on the aircraft. Connect the aircraft to a PC with a Type-C USB cable.
2. Run the DJI Assistant 2. Click the corresponding device name and then the firmware update tag.
4. Select the firmware version required. Make sure to connect to the Internet when downloading the firmware.
5. Restart the device after the firmware update is complete.

H20 series Firmware Update

1. Install the H20 series payload onto the aircraft. Power on the aircraft. Connect the aircraft to a PC with a Type-C USB cable.
2. Run the DJI Assistant 2. Click the corresponding device name and then the H20 series firmware update tag.
4. Select the firmware version required. Make sure to connect to the Internet when downloading the firmware.
5. Restart the device after the firmware update is complete.



- The battery firmware is included in the aircraft firmware. Be sure to update all the batteries' firmware.
 - The aircraft battery level should be above 25% and the remote controller battery level should be above 50% for the firmware update process.
 - Make sure all the devices are connected normally during update.
 - It is normal that the gimbal will go limp, the aircraft status indicator blinks abnormally when the aircraft reboots. Wait patiently until the update is complete.
 - Make sure to keep the aircraft away from people and animals during firmware update, system calibration and parameter setting.
 - Be sure to update the firmware to the latest version to ensure flight safety.
 - After the firmware update is completed, the remote controller and the aircraft may be disconnected. If necessary, re-link them.
-

* Supported later.

Using the Upward Gimbal Connector

The Matrice 300 RTK Upward Gimbal Connector is used to mount a compatible payload to the top of the Matrice 300 RTK aircraft. Its design gives it an IP44 Ingress Protection (only when equipped with a waterproof payload), in accordance with the global IEC 60529 standard.

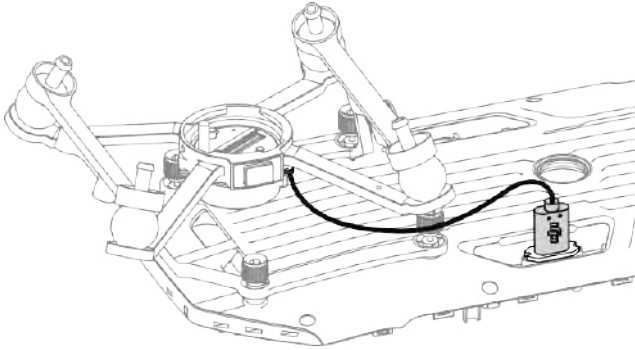

Using the Dual Gimbal Connector

The Matrice 300 RTK Dual Gimbal Connector is used to mount a compatible payload to the bottom of the Matrice 300 RTK aircraft. Its design gives it an IP44 Ingress Protection (only when equipped with a waterproof payload), in accordance with the global IEC 60529 standard.

1. Remove the single downward gimbal connector.

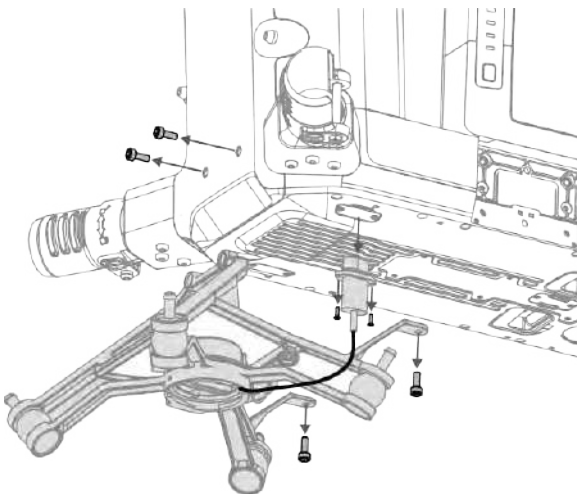

2. Attach the Dual Gimbal Connector, and connect the cables.

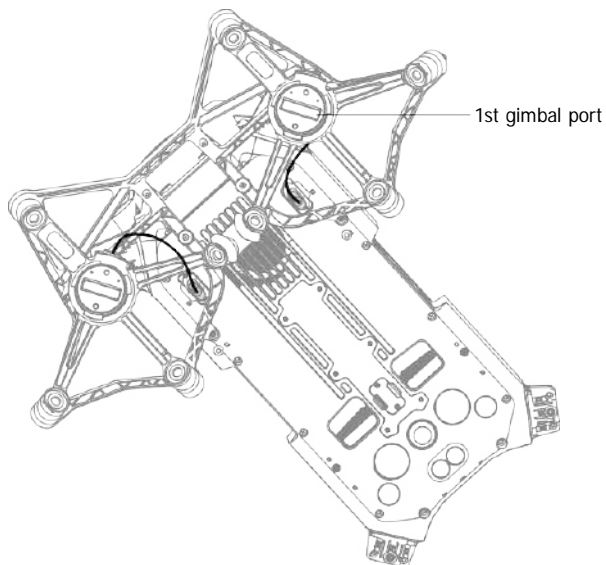
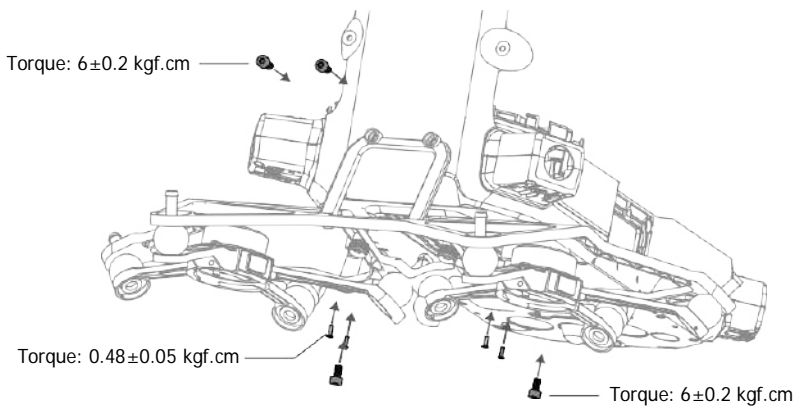

Using the CSM Radar

Installing and Connecting

CSM Radar can be used with M300 RTK. Follow the steps below to install and connect it.

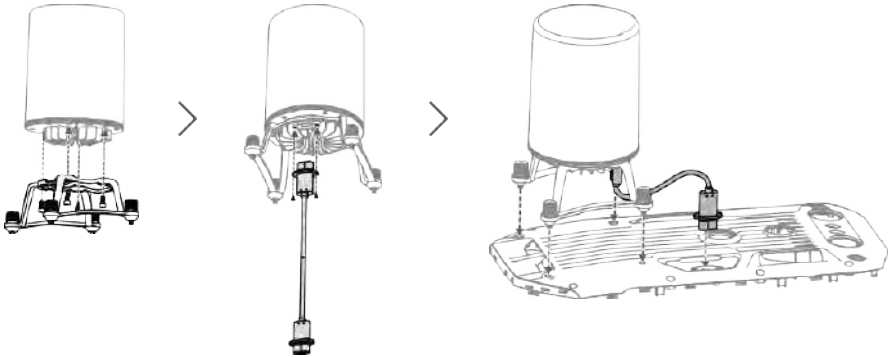

Using

For an added safety measure, a Circular Scanning Millimeter-Wave (CSM) Radar with a detection range between 1.5 to 30 m can be mounted on top of the aircraft.

Detection Range

Detection angle: 360 ° in horizontal direction, 60° in vertical direction, and 45° in upper direction.
 Detection distance: 1.5-30 m.

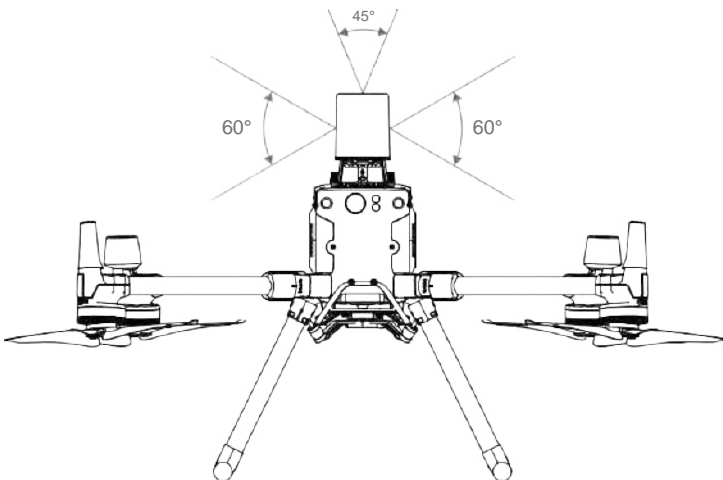



- Note that the aircraft cannot sense obstacles that are not within the detection range. Fly with caution.
 - The effective detection distance varies depending on the size and material of the obstacle. For example, when sensing strong reflective objects (such as buildings), the effective detection distance is around 30 m. When sensing weak reflective objects (such as dry tree branches), the distance is around 15 m. Obstacle sensing may malfunction or be invalid in areas outside of the effective detection distance.
-

Obstacle Avoidance Function Usage

The radar obstacle avoidance function should be enabled in the DJI Pilot App. Set the aircraft safety distance (recommended to be greater than 2.5 meters) in app. Maintain a flight speed less than 10 m/s when the radar module is in use. Flying higher than 4 meters is recommended for better obstacle avoidance performance.



- DO NOT touch or let your hands or body come in contact with the metal parts of the radar module when powering on or immediately after flight as they may be hot.
 - In Manual operation mode, users have complete control of the aircraft. Pay attention to the flying speed and direction when operating. Be aware of the surrounding environment and avoid the blind spots of the radar module.
 - If another device is installed on the aircraft (such as Manifold 2), please avoid blocking the radar FOV. If the radar FOV is blocked, the obstacle avoidance performance of the radar may decrease. Please fly with caution.
 - Obstacle Avoidance is disabled in Attitude mode.
 - Maintain full control of the aircraft at all times and DO NOT rely on the radar module and DJI Pilot app. Keep the aircraft within VLOS at all times. Use your discretion to operate the aircraft manually to avoid obstacles.
 - The radar modules sensitivity can be reduced when operating several radar equipped aircraft within a short distance from each other. Fly with caution.
 - Before use, make sure that the radar module is clean and the outer protective cover is not cracked, chipped, sunken, or misshapen.
 - DO NOT attempt to disassemble any part of the radar module that has already been mounted prior to shipping.
 - The radar module is a precision instrument. DO NOT squeeze, tap, or hit the radar module.
-



- If the radar module frequently detects obstacles incorrectly, check to make sure the mounting bracket and the aircraft landing gear are properly secured. If the radar module still does not work, contact DJI Support or a DJI authorized dealer.
 - Keep the protective cover of the radar module clean. Clean the surface with a soft damp cloth and air dry before using again.
-

Specifications

| | |
|--|--|
| Model | DR2424R |
| Operating Frequency | 24.05-24.25 GHz |
| Power Consumption | 12 W |
| Transmitter Power (EIRP) | SRRC: <13 dBm NCC/MIC/KCC/CE/FCC: <20 dBm |
| IP Rating | IP45 |
| Dimensions | 75×75×105.4 mm |
| Weight (without mounting bracket and cables) | 336 g |
| Operating Temperature | -20° to 50°C (-4° to 122° F) |

Carrying Case Description

This diagram is intended to illustrate how to place the M300 RTK parts and components. In-the-box items are subject to the contents received.

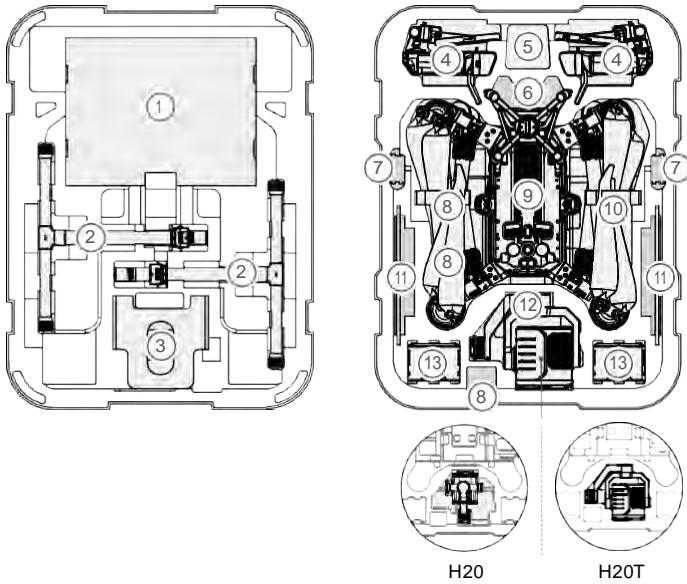

- | | |
|------------------------------|-------------------------------------|
| 1. Propeller ×4 | 8. USB Charger |
| 2. Landing Gear | 9. Aircraft Body |
| 3. Aircraft Protector | 10. CSM Radar |
| 4. Remote Controller | 11. Mobile Device (e.g. iPad) |
| 5. Remote Controller Lanyard | 12. Gimbal and Camera (H20 / H20T) |
| 6. Upward Gimbal Connector | 13. TB60 Intelligent Flight Battery |
| 7. WB37 Intelligent Battery | |

 Please note that the sleeves of the landing gears should be put in the way shown in the diagram, to avoid damage on the propellers when the carrying case is closed.

Using the Aircraft Cradle

Once the aircraft needs to be operated upside down, make sure to use aircraft cradle for protection.

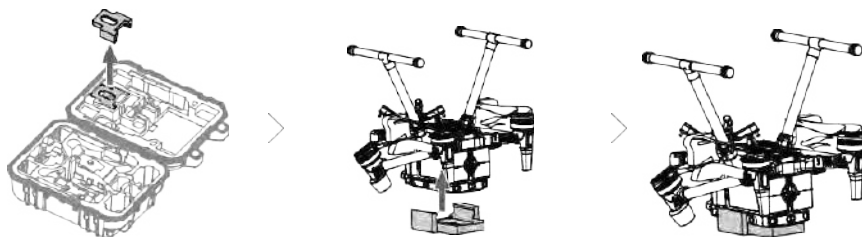

Extended Screw Holes Description

Use the specified screw to avoid damage to the thread of the screw hole. Make sure that the accessories are firmly installed.

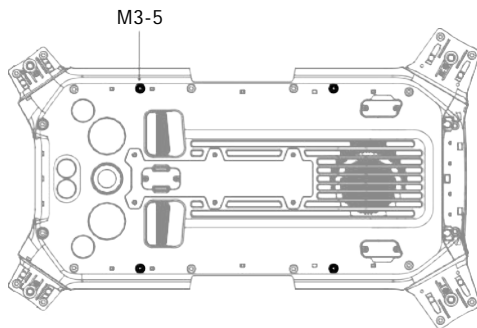

DJI Support

<https://www.dji.com/support>

This content is subject to change.

Download the latest version from

<https://www.dji.com/matrice-300/downloads>

If you have any questions about this document, please contact DJI by sending a message to DocSupport@dji.com.

Copyright © 2020 DJI All Rights Reserved.